

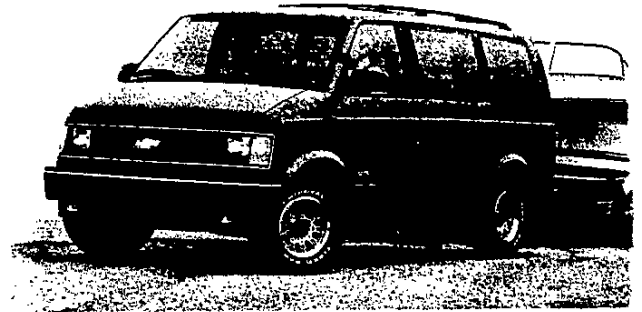

ASTRO PASSENGER VAN

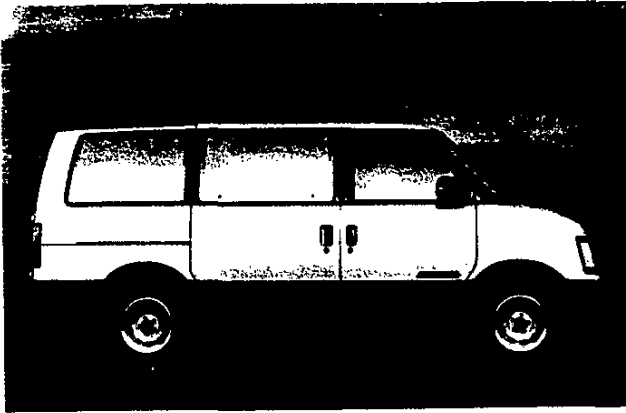

CONTENTS

	<u>Page</u>
MODELS	2
ASTRO CS TRIM	3
ASTRO CL (YC6) TRIM	4
ASTRO LT (YC7) TRIM	5
POWERTRAINS	6
STANDARD SUSPENSION	8
OPTIONAL SUSPENSION	9
WHEELS AND TIRES/STEERING AND BRAKES	10
ELECTRICAL/COOLING	11
DIMENSIONS	12
OPTIONS	13
COLOR COMBINATIONS	15
EXTERIOR COLORS	B
INTERIOR TRIM	C
SEATS	D
TRAILERING	E



TWO-WHEEL DRIVE PASSENGER VAN

ASTRO PASSENGER VAN	MODEL NUMBER	WB (IN.)	GVWR (LBS.)	MAX' PAYLOAD (LBS.)	PASS. CAP. STD/OPT	STD ENGINE/TRANS	OPT ENGINE/TRANS
	CM10906	111	5600	1774	5/7/8	4.3L V6/A4	4.3L V6/A4 (LU2)
ASTRO EXTENDED PASSENGER VAN	CM11006	111	5850	1937	5/7/8	4.3L V6/A4	4.3L V6/A4 (LU2)
							

ASTRO PASSENGER VAN
The standard Astro Passenger Van model is offered in a 5600-lb. GVWR with a choice of seating configurations.

ASTRO EXTENDED PASSENGER VAN
The Astro Extended Passenger Van retains the same 111-in. wheelbase as the regular-length model, while adding 10-inches to the rear frame for increased cargo capacity.

ALL-WHEEL DRIVE PASSENGER VAN

ASTRO ALL-WHEEL DRIVE PASSENGER VAN	MODEL NUMBER	WB (IN.)	GVWR (LBS.)	MAX' PAYLOAD (LBS.)	PASS. CAP. STD/OPT	STD ENGINE/TRANS	OPT ENGINE/TRANS
	CL10906	111	5800	1644	5/7/8	4.3L V6/A4	—
	CL10906/C6M	111	5950	1794	5/7/8	4.3L V6/A4	—
ASTRO ALL-WHEEL DRIVE EXTENDED PASSENGER VAN	CL11006	111	6100	1863	5/7/8	4.3L V6/A4	—
							

ASTRO ALL-WHEEL DRIVE PASSENGER VAN
The Astro All-Wheel Drive Passenger Van offers two GVWRs with full-time All-Wheel Drive.

ASTRO ALL-WHEEL DRIVE EXTENDED PASSENGER VAN
The Astro All-Wheel Drive Extended Passenger Van retains the same 111-in. wheelbase as the regular-length model, while adding 10-inches to the rear frame for increased cargo capacity.

*Based on curb weight

ASTRO PASSENGER VAN SEATING ARRANGEMENTS

STANDARD: 5-PASSENGER (ZP5)
Includes high-back front bucket seats and a standard removable 3-passenger bench seat. With YC7 trim, includes reclining front bucket seats and a removable split-back reclining 3-passenger bench seat with folding armrests.

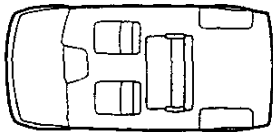

OPTIONAL: 7-PASSENGER (RPO ZP7)
Includes four high-back bucket seats and a removable 3-passenger bench seat. Also includes A78 reclining seat backs on bucket seats. With YC7 trim, includes four reclining bucket seats (2 front and 2 center), and a removable split-back reclining 3-passenger bench seat with folding armrests.

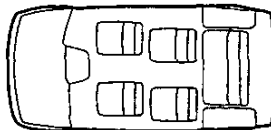

OPTIONAL: 8-PASSENGER (RPO ZP8)
Includes two high-back buckets and two removable 3-passenger bench seats. With YC7 trim, includes two reclining bucket seats and two removable split-back reclining 3-passenger bench seats with folding armrests.



ASTRO PASSENGER VAN WINDOW ARRANGEMENTS

STANDARD
(Includes Rear Door Windows, Side Sliding Door Window and LH Center Window)

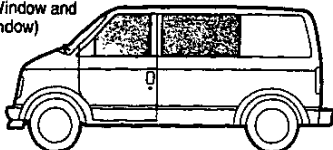

W/ZW6
(Includes RH and LH Rear Quarter Windows)

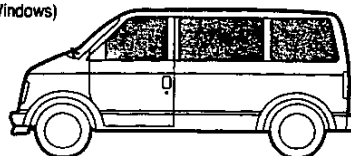

NOTE: Right face profile is identical to left face profile.

ASTRO CS

(ZW9)

The CS trim level is the standard trim level of the Astro series. It is designed to offer buyers a high level of standard features when purchasing a standard-level vehicle.

The following features are standard.



Some equipment shown may be optional or extra cost.

POWERTRAIN/CHASSIS

- 1 ALTERNATOR: 85 Amp Delcotron.
- 1 BATTERY: 12 volt, neg. ground; 630 CCA @ 0 degrees F.
- 1 BRAKES: Power; vacuum (CM10906 only). Front-disc. Rear-drum. Power; hydraulic (CM11006, CL10906 and CL11006). Front-disc. Rear-drum. Includes four-wheel anti-lock brake system.
- 1 ENGINE: 4.3-liter V6 EFI. 150 net horse power @ 4000 rpm and 230 lb. ft. of net torque @ 2400 rpm.
- 1 EXHAUST: Single.
- 1 FRAME: Integral body design with boxed section front stub frame.
- 1 FUEL TANK: 27.0-gallon (approx.).
- 1 REAR AXLE: Hypoid, Semi-Floating. Ratio: 3.23 on CM10906 and CM11006. 3.42 on CL10906 and CL11006.
- 1 SHOCK ABSORBERS: Front and Rear. 32 mm piston dia.
- 1 STABILIZER BAR: Front. 1.26 inch dia. on CM10906 and CM11006. 1.18 inch dia. on CL 10906 and CL11006.
- 1 STEERING: Integral Power Variable Ratio-16/13:1.
- 1 SUSPENSION: Front-Independent with computer-selected springs. Rear-wheel drives with coil springs; all-wheel drives with torsion bars. Rear-Composite leaf springs.
- 1 TRANSMISSION: 4-Speed automatic with overdrive.

EXTERIOR

- 1 AIR DAM: Lower body color.
- 1 BUMPER: Front and rear painted lower body color. Front includes bumper guards on CL10906 and CL11006.
- 1 COLORS: Choice of ten in a solid paint scheme. See Color and Trim specifications for details.
- 1 DOORS: Driver and passenger front side, sliding RH side cargo, and RH and LH rear load doors.
- 1 GRILLE: Black molded plastic.
- 1 HEADLAMPS: Single halogen.
- 1 HORN: Dual high-note and low-note.
- 1 LICENSE PLATE BRACKET: Front only.
- 1 MIRRORS: Black RH and LH fixed type with pivoting arm and adjustable heads. Head size is 4³/₄" x 7".
- 1 NAMEPLATE: Astro in bright finish.
- 1 SPARE TIRE/WHEEL: Compact; mounted under floor.
- 1 TIRES: Four all-season steel belted radials. P205/75R15 on CM10906 and CL10906 and P215/75R15 on CM11006 and CL11006.
- 1 UNDERBODY PROTECTION: Entire underbody sprayed with hot melt wax.
- 1 WHEELS: Four 15.0" x 6.0" argent steel wheels. Includes bright metal hub caps with black trim.
- 1 WINDOW PILLARS: Black.

INTERIOR

- 1 ARMREST: RH and LH front door.
- 1 CHIMES: Headlamp warning.
- 1 CIGARETTE LIGHTER: Includes ashtray light.
- 1 COAT HOOKS: Two LH and one RH.
- 1 COLORS: Choice of four. Blue, Garnet, Saddle or Gray.
- 1 DOME LAMP: Two with front door actuated switches.
- 1 DOOR PANELS: Color-keyed vinyl with front door map pockets.
- 1 DOOR SILL PLATE: Bright plastic.
- 1 FLOOR COVERING: Color-keyed carpeting on wheelhouses and floor.
- 1 FUEL FILLER DOOR: Remote release.
- 1 GAGES: Includes speedometer, odometer, fuel level, voltmeter, oil pressure, coolant temperature, trip odometer and additional telltale lights.
- 1 HEADLINER: Full length, color-keyed, foam backed cloth.
- 1 HEATER: Deluxe with windshield and side window defoggers.
- 1 MIRRORS: 10 inch rearview.
- 1 RADIO: Electronically-tuned AM with two 6" diameter front dash speakers and fixed mast antenna. (Refer to Delco Electronics brochure in RPO Detail for further information.)
- 1 SEATS: Front high-back adjustable buckets with all-vinyl trim plus removable center 3-passenger bench.
- 1 STEERING WHEEL: Black vinyl 4-spoke.
- 1 STORAGE COMPARTMENT: Molded, color-keyed plastic in LH rear quarter area.
- 1 STOWAGE BOX: Located in front face of engine cover extension. Includes beverage holder.
- 1 SUNSHADES: Color-keyed RH and LH padded cloth with RH visor mirror.
- 1 SWING-OUT GLASS: Included on sliding side door.
- 1 TOOLS: Screw-operated scissor-type jack with ratchet handle and extension and two wheel blocks. Located behind side panel at right rear.
- 1 WINDOWS: Tinted glass.
- 1 WINDSHIELD WIPERS: Intermittent.

ASTRO CL

(YC6)

The CL trim level is an optional trim level for the Astro series. It is designed to offer buyers an increased level of comfort and convenience features compared to the standard CS trim.

The following features are standard. Bold type denotes equipment in addition to or replacing that of the CS trim.

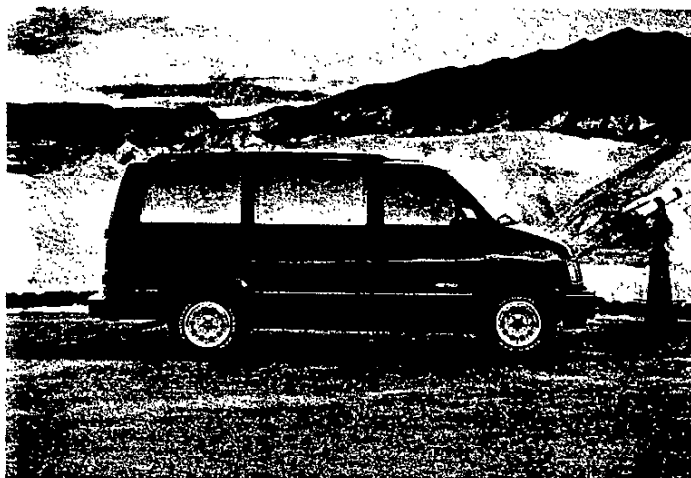

Some equipment shown may be optional or extra cost.

POWERTRAIN/CHASSIS

- ALTERNATOR: 85 Amp Delcotron.
- BATTERY: 12 volt, neg. ground; 630 CCA @ 0 degrees F.
- BRAKES: Power; vacuum (CM11006, CM10906 only). Front-disc. Rear-drum. Power; hydraulic (CL10906 and CL11006). Front-disc. Rear-drum. Includes four-wheel anti-lock brake system.
- ENGINE: 4.3-liter V6 EFI. 150 net horsepower @ 4000 rpm and 230 lb. ft. of net torque @ 2400 rpm.
- EXHAUST: Single.
- FRAME: Integral body design with boxed section front stub frame.
- FUEL TANK: 27.0-gallon (approx.).
- REAR AXLE: Hypoid, Semi-Floating. Ratio: 3.23 on CM10906 and CM11006. 3.42 on CL10906 and CL11006.
- SHOCK ABSORBERS: Front and Rear. 32 mm piston dia.
- STABILIZER BAR: Front. 1.26 inch dia. on CM10906 and CM11006. 1.18 inch dia. on CL10906 and CL11006.
- STEERING: Integral Power Variable Ratio-16/13:1.
- SUSPENSION: Front-Independent with computer-selected springs. Rear-wheel drives with coil springs; all-wheel drives with torsion bars. Rear-Composite leaf springs.
- TRANSMISSION: 4-Speed automatic with overdrive.

EXTERIOR

- AIR DAM: Includes fog lamps.
- BUMPER: Front and rear lower body color with matching color-keyed end caps, rub strips with bright trim and rear black combination top step surface.
- COLORS: Choice of ten in a solid paint scheme. See Color and Trim specifications for details.
- DOORS: Driver and passenger front side, sliding RH side cargo and RH and LH rear load doors.
- GRILLE: Black molded plastic with argent paint on feature surfaces.
- HEADLAMPS: Single halogen.
- HORN: Dual high-note and low-note.
- LICENSE PLATE BRACKET: Front only.
- MIRRORS: Black RH and LH fixed type with pivoting arm and adjustable heads. Head size is 4³/₄" x 7".
- MOLDINGS: Black body side with bright trim.
- NAMEPLATE: Astro in bright finish.
- SPARE TIRE/WHEEL: Compact; mounted under floor.
- TIRES: Four all-season steel belted radials. P205/75R15 on CM10906 and CL10906 and P215/75R15 on CM11006 and CL11006.
- UNDERBODY PROTECTION: Entire underbody sprayed with hot melt wax.
- WHEEL OPENING MOLDINGS: Black.
- WHEELS: Four 15.0" x 6.5" argent steel rally wheels. Bright trim rings with black center cap.
- WINDOW PILLARS: Black.

INTERIOR

- ARMREST: RH and LH front door.
- CHIMES: Headlamp warning.
- CIGARETTE LIGHTER: Includes ashtray light.
- COAT HOOKS: Two LH and one RH.
- COLORS: Choice of four. Blue, Garnet, Saddle or Gray.
- DOME LAMP: Two with front door, rear door and sliding door-actuated switches. Includes door-jamb override switch.
- DOOR PANELS: Color-keyed expanded vinyl with carpet inserts, insulation and front door map pockets.
- DOOR SILL PLATE: Bright plastic.
- FLOOR COVERING: Color-keyed carpeting on wheelhouses and floor.
- FLOOR MATS: Front and rear color-keyed.
- FUEL FILLER DOOR: Remote release.
- GAGES: Includes speedometer, odometer, fuel level, voltmeter, oil pressure, coolant temperature, trip odometer and additional telltale lights.
- HEADLINER: Full length, color-keyed, foam backed cloth.
- HEATER: Deluxe with windshield and side window defoggers.
- LAMPS: Stepwell and storage box.
- MIRRORS: 10 inch rearview.
- RADIO: Electronically-tuned AM with two 6" diameter front dash speakers and fixed mast antenna. (Refer to Delco Electronics brochure in RPO Detail for further information.)
- SEATS: Front high-back adjustable buckets with all-vinyl trim plus removable center 3-passenger bench. Choice of Custom Vinyl or Custom Cloth with Vinyl trim.
- STEERING WHEEL: 4-spoke Custom.
- STORAGE COMPARTMENT: Molded, color-keyed plastic in LH rear quarter area.
- STOWAGE BOX: Located in front face of engine cover extension. Includes beverage holder.
- SUNSHADES: Color-keyed RH and LH padded cloth with RH visor mirror with light.
- SWING-OUT GLASS: Included on sliding side door and rear door.
- TOOLS: Screw-operated scissor-type jack with ratchet handle and extension and two wheel blocks. Located behind side panel at right rear.
- WINDOWS: Tinted glass.
- WINDSHIELD WIPERS: Intermittent.

TRANSMISSION AUTOMATIC:	
MODEL	AUTOMATIC 4-SPEED w/OVERDRIVE 700R4
RPO CODE	MX0
GEAR RATIOS	
First	3.06
Second	1.63
Third	1.00
Fourth	.70
Reverse	2.29
GEAR TYPE	Planetary
TORQUE CONVERTER	
Element Types	Pump/Stator/Turbine
Lock-up Clutch	Automatic
LUBRICANT CAPACITY (pints)	
Dry Fill	19
Refill	10

AXLES	REAR				FRONT – ALL-WHEEL DRIVE	
MAKE AND CAPACITY (lbs.)	GM 3150				GM 3150	
PINION & RING GEARS	Hypoid				Hypoid	
Type						
Ratio	3.23	3.42	3.73	4.10	3.42	3.73
Pinion Teeth	13	12	11	9	12	11
Ring Gear Teeth	42	41	41	37	41	41
Ring Gear Dia. (in.)	7.5	7.5	7.5	7.5	7.25	7.25
DIFFERENTIAL						
Type	2-Pinion				2-Pinion	
Bearings, Type	Tapered Roller				Tapered Roller	
AXLE SHAFTS						
Type	Semi-Floating				—	
Min. Diameter (in.)	Integral Shaft and Drive Flange				—	
HOUSING @ SPRING SEAT						
Section Diameter and Thickness (in.)	2.69 x .116-.175				—	

		TWO-WHEEL DRIVE		ALL-WHEEL DRIVE	
MODEL	ASTRO PASSENGER VAN	ASTRO EXTENDED PASSENGER VAN	ASTRO ALL-WHEEL DRIVE PASSENGER VAN	ASTRO ALL-WHEEL DRIVE EXTENDED PASSENGER VAN	
MODEL NUMBER	CM10906	CM11006	CL10906	CL11006	
STANDARD SUSPENSION					
PAYLOAD (Maximum lbs.) ¹	1774	1937	1644	1863	
GVWR (lbs.)	5600	5850	5800	6100	
GAWR (lbs.): Front Rear	2700 2900	2700 3150	2906 2906	3050 3150	
FRONT SUSPENSION Type Standard Spring Cap. (Total lbs.)	Ind. Coil Spring 2700	Ind. Coil Spring 2700	Torsion Bar 3050	Torsion Bar 3050	
Front Shock Absorbers Piston Diameter (mm)	32	32	32	32	
Front Stabilizer Bar Diameter (in.)	1.26	1.26	1.18	1.18	
REAR SUSPENSION Type	Composite Leaf Spring	Composite Leaf Spring	Composite Leaf Spring	Composite Leaf Spring	
Standard Spring Cap. (Total lbs.) Leaves Per Spring Leaf Total Thickness (in.)	2900 1 .813	3150 1 .813	3150 1 .813	3150 1 .813	
Rear Shock Absorbers Piston Diameter (mm)	32	32	32	32	
FRONT AXLE Type Make Maximum Capacity (lbs.) Standard Hub Locks Pinion/Ring Gear Type	— — 2700 — —	— — 2700 — —	Independent GM 3050 Insta-Trac Hypoid	Independent GM 3050 Insta-Trac Hypoid	
REAR AXLE Type Make Maximum Capacity (lbs.) Pinion/Ring Gear Type	Semi-Floating GM 3150 Hypoid	Semi-Floating GM 3150 Hypoid	Semi-Floating GM 3150 Hypoid	Semi-Floating GM 3150 Hypoid	
STANDARD TIRES Tire Capacity (lbs.) each Front/ Rear Inflation (psi) Max. Revolutions per mile @ 45 MPH	Tubeless SBR P205/75R15 1453 35 769	Tubeless SBR P215/75R15 1583 35 753	Tubeless SBR P205/75R15 1453 35 769	Tubeless SBR P215/75R15 1583 35 753	
WHEELS Size (in.) Front/Rear Capacity (lbs.) each Bolt Holes Bolt Circle Diameter (in.) Offset (mm)	15.0 x 6.00 1575 5 5 13	15.0 x 6.00 1575 5 5 13	15.0 x 6.00 1575 5 5 13	15.0 x 6.00 1575 5 5 13	

¹Based on Curb Weight.

		TWO-WHEEL DRIVE		ALL-WHEEL DRIVE	
MODEL	ASTRO PASSENGER VAN	ASTRO EXTENDED PASSENGER VAN	ASTRO PASSENGER VAN	ASTRO EXTENDED PASSENGER VAN	
MODEL NUMBER	CM10906	CM11006	CL10906	CL11006	
OPTIONAL SUSPENSION					
OPTION	—	—	C6M	—	
PAYLOAD (Maximum lbs.) ¹	—	—	1794	—	
GVWR (lbs.)	—	—	5950	—	
GAWR (lbs.) Front Rear	— —	— —	3050 3150	— —	
FRONT SUSPENSION					
Type	—	—	Torsion Bar	—	
Standard Spring Cap. (Total lbs.)	—	—	3050	—	
Front Shock Absorbers Piston Diameter (mm)	—	—	32	—	
Front Stabilizer Bar Diameter (in.)	—	—	1.18	—	
REAR SUSPENSION					
Type	—	—	Composite Leaf Spring	—	
Standard Spring Cap. (Total lbs.)	—	—	3150	—	
Leaves Per Spring	—	—	1	—	
Leaf Total Thickness (in.)	—	—	.813	—	
Rear Shock Absorbers Piston Diameter (mm)	—	—	32	—	
FRONT AXLE					
Type	—	—	Independent	—	
Make	—	—	GM	—	
Maximum Capacity (lbs.)	—	—	3050	—	
Standard Hub Locks	—	—	Insta-Trac	—	
Pinion/Ring Gear Type	—	—	Hypoid	—	
REAR AXLE					
Type	—	—	Semi-Floating	—	
Make	—	—	GM	—	
Maximum Capacity (lbs.)	—	—	3150	—	
Pinion/Ring Gear Type	—	—	Hypoid	—	
STANDARD TIRES					
Capacity (lbs.) each Front/Rear	— —	— —	Tubeless SBR P215/70R15 1583	— —	
Inflation (psi) Maximum	—	—	35	—	
Revolutions per mile @ 45 MPH	—	—	753	—	
WHEELS					
Size (in.) Front/Rear	—	—	15.0 x 6.0	—	
Capacity (lbs.) each	—	—	1575	—	
Bolt Holes	—	—	5	—	
Bolt Circle Diameter (in.)	—	—	5	—	
Offset (mm)	—	—	13	—	

¹Based on Curb Weight.

ASTRO PASSENGER VAN

WHEELS AND TIRES/
STEERING AND BRAKES

KEY: — Not Available BW — Blackwall HWY — Highway
 AS — All-Season WW — Whitewall ON-OFF — On-Off Road
 SBR — Steel-Belted Radial Ply WL — White Lettered WOL — White Outline Lettered

TIRES

TIRE SIZE	TYPE	RPO	PLY	LOAD RANGE	TIRE CAPACITY (LBS. EA.)	INFLATION (PSI) MAX.	WHEEL SIZE (IN.)	WHEEL CAPACITY (LBS. EA.)	BOLT HOLES	BOLT CIRCLE DIA. (IN.)	OFFSET (MM)	REV. PER MILE @ 45 MPH
P205/75R15	AS/SBR/BW	QCE	—	—	1453	35	15.0 x 6.0	1575	5	5	13	769
P205/75R15	AS/SBR/WL	QCF	—	—	1453	35	15.0 x 6.0	1575	5	5	13	769
P205/75R15	AS/SBR/WW	QCG	—	—	1453	35	15.0 x 6.0	1575	5	5	13	769
P215/75R15	AS/SBR/BW	QCU	—	—	1583	35	15.0 x 6.0	1575	5	5	13	753
P215/75R15	AS/SBR/WW	QCV	—	—	1583	35	15.0 x 6.0	1575	5	5	13	753
P215/75R15	AS/SBR/WL	QCW	—	—	1583	35	15.0 x 6.0	1575	5	5	13	753
P245/60R15 ¹	AS/SBR/WOL	QWT	—	—	1593	35	15.0 x 6.5	1575	5	5	13	784

¹ Requires FE3 Suspension or BYP Sport Package.

OPTIONAL WHEELS

RPO	DESCRIPTION	WHEEL SIZE (IN.)	CAPACITY	BOLT HOLES	BOLT CIRCLE DIA. (IN.)	OFFSET (MM)
PF3	Wheels — Aluminum (and Special Hub Caps)	15.0 x 6.5	1575	5	5	10
ZJ7	Wheels — Rally (Included w/BYP Sport Pkg., YC6 CL, YC7 LT or FE3 Suspension; Rally Wheels Include Special Hub Caps and Trim Rings)	15.0 x 6.5	1575	5	5	10

MODEL	ASTRO PASSENGER VAN	ASTRO EXTENDED PASSENGER VAN	ASTRO ALL-WHEEL DRIVE PASSENGER VAN	ASTRO ALL-WHEEL DRIVE EXTENDED PASSENGER VAN
MODEL NUMBER	CM10906	CM11006	CL10906	CL11006

STEERING

Type	Integral Power	Integral Power	Integral Power	Integral Power
Steering Ratio (Variable)	16/13:1	16/13:1	16/13:1	16/13:1
Turning Diameter Curb-to-Curb (ft.)	39.5	39.5	40.5	40.5
Wall-to-Wall (ft.)	40.5	40.5	41.5	41.5

BRAKES

GVWR (lbs.)	5600	5850	5800	5950	6100
Type	Vacuum Power Front Disc/Rear Drum with 4-Wheel Anti-Lock System	Hydraulic Power Front Disc/Rear Drum with 4-Wheel Anti-Lock System	Hydraulic Power Front Disc/Rear Drum with 4-Wheel Anti-Lock System		Hydraulic Power Front Disc/Rear Drum with 4-Wheel Anti-Lock System
Booster (Diaphragm Diameter) (in.)	7.9 x 7.9 Tandem	Hydro-boost	Hydro-boost		Hydro-boost
Front Rotor Size (Diameter x Thickness) (in.)	11.86 x 1.04	11.57 x 1.25	11.57 x 1.25		11.57 x 1.25
Front Facing Contact Per Axle (sq. in.)	37.9	34.8	34.8		34.8
Rear Drum Size (Diameter x Width) (in.)	9.5 x 2.0	9.5 x 2.0	9.5 x 2.0		9.5 x 2.0
Rear Facing Contact Per Axle (sq. in.)	64.7	64.7	64.7		64.7
Parking Brake Type	Cable to Rear Wheels	Cable to Rear Wheels	Cable to Rear Wheels		Cable to Rear Wheels

*NOTE: Alternator is available only as part of Noted RPO.

MODEL	ASTRO PASSENGER VAN	ASTRO EXTENDED PASSENGER VAN	ASTRO ALL-WHEEL DRIVE PASSENGER VAN	ASTRO ALL-WHEEL DRIVE EXTENDED PASSENGER VAN
MODEL NUMBER	CM10906	CM11006	CL10906	CL11006
ELECTRICAL				
ENGINE STD/OPT	4.3L V6/—	4.3L V6/—	4.3L V6/—	4.3L V6/—
STANDARD BATTERY Cold Cranking Amps @ 0° F @ -20° F Reserve Capacity Min. @ 80° F	630 470 115	630 470 115	630 470 115	630 470 115
STANDARD ALTERNATOR Max. Capacity (Amps) Max Watts @ 12 Volts Nominal Amp @ Idle (approx.) Drive Pulley Ratio Model Number	85 1020 30 3.2:1 CS130	85 1020 30 3.2:1 CS130	85 1020 30 3.2:1 CS130	85 1020 30 3.2:1 CS130
OPTIONAL ALTERNATOR¹ Max. Capacity (Amps) Max Watts @ 12 Volts Nominal Amp @ Idle (approx.) Drive Pulley Ratio Model Number	w/C60 Air or C69 Front/Rear Air 100 1200 36 3.2:1 CS130	w/C60 Air or C69 Front/Rear Air 100 1200 36 3.2:1 CS130	w/C60 Air or C69 Front/Rear Air 100 1200 36 3.2:1 CS130	w/C60 Air or C69 Front/Rear Air 100 1200 36 3.2:1 CS130

ALTERNATOR CURVES

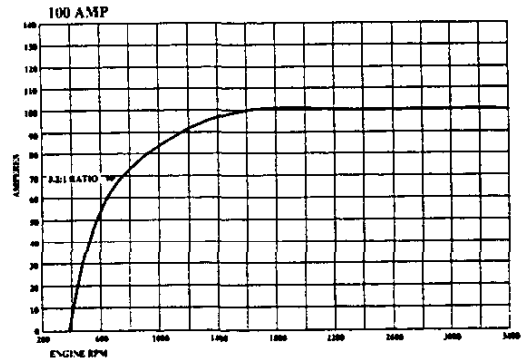
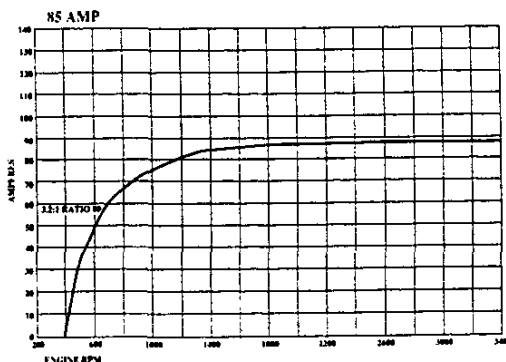

COOLING

MODEL	ASTRO PASSENGER VAN	ASTRO EXTENDED PASSENGER VAN	ASTRO ALL-WHEEL DRIVE PASSENGER VAN	ASTRO ALL-WHEEL DRIVE EXTENDED PASSENGER VAN
MODEL NUMBER	CM10906	CM11006	CL10906	CL11006
STANDARD COOLING SYSTEM				
ENGINE Radiator Thickness (in.) System Capacity (gal.) Fan-No. Blades x Dia. x Pitch (in.)	4.3L .93 3.4 3 x 18.1 x 2.72	4.3L .93 3.4 3 x 18.1 x 2.72	4.3L .93 3.4 3 x 18.1 x 2.72	4.3L .93 3.4 3 x 18.1 x 2.72
OPTIONAL COOLING SYSTEMS				
OPT. AIR CONDITIONING Radiator Thickness (in.) System Capacity (gal.) Fan-No. Blades x Dia. x Pitch (in.)	C60 ¹ .93 3.4 5 x 19 x 2.7	C60 ¹ .93 3.4 5 x 19 x 2.7	C60 ¹ .93 3.4 5 x 19 x 2.7	C60 ¹ .93 3.4 5 x 19 x 2.7
OPT. H.D. RADIATOR AND TRANS. OIL COOLER Radiator Thickness (in.) System Capacity (gal.) Fan-No. Blades x Dia. x Pitch (in.)	V02 ² .93 3.4 3 x 18.1 x 2.72	V02 ² .93 3.4 3 x 18.1 x 2.72	V02 ² .93 3.4 3 x 18.1 x 2.72	V02 ² .93 3.4 3 x 18.1 x 2.72

¹w/o V02 Cooling, Includes V01 Cooling

²Included w/Z82 Trailing

MODEL		ASTRO PASSENGER VAN	ASTRO EXTENDED PASSENGER VAN	ASTRO ALL-WHEEL DRIVE PASSENGER VAN	ASTRO ALL-WHEEL DRIVE EXTENDED PASSENGER VAN
MODEL NUMBER		CM10906	CM11006	CL10906	CL11006
EXTERIOR DIMENSIONS					
BODY					
Wheelbase (in.)	WB	111.0	111.0	111.0	111.0
Overall Length (in.)	OAL	176.8	186.8	176.8	186.8
Overall Height Nominal (in.)	OAH	73.7	73.7	73.7	73.7
Maximum Width (in.)	OAW	77.0	77.0	77.0	77.0
Bumper To Axle (in.) Front/Rear	BA	30.6/35.2	30.6/45.2	30.6/35.2	30.6/45.2
Ground To Top of Rear Load Floor (in.)	—	24.4	24.6	24.4	24.6
Ground Clearance (in.) Front/Rear	—	7.8/7.3	7.8/7.3	7.6/7.3	7.6/7.3
SIDE LOAD DOOR Opening Height/Width (in.)	—	44.5/34.5	44.5/34.5	44.5/34.5	44.5/34.5
REAR LOAD DOOR Opening Height/Width (in.)	—	44.7/57.0	44.7/57.0	44.7/57.0	44.7/57.0
Step Up Height (in.) Front Door	—	16.3	16.3	16.3	16.3
Side Sliding Door	—	17.4	17.4	17.4	17.4
SIGN PANEL AREA Side Panel/Front Door (in.)	Shaded Area	18 x 80.5/18 x 35	18 x 90.5/18 x 35	18 x 80.5/18 x 35	18 x 90.5/18 x 35
INTERIOR DIMENSIONS					
Head Room (in.) Front/Middle/Rear	HR	39.2/37.9/38.3	39.2/37.9/38.3	39.2/37.9/38.3	39.2/37.9/38.3
Leg Room (in.) Front/Middle/Rear	LR	41.6/36.5/38.5	41.6/36.5/38.5	41.6/36.5/38.5	41.6/36.5/38.5
Shoulder Room (in.) Front/Middle/Rear	SR	64.0/67.8/67.8	64.0/67.8/67.8	64.0/67.8/67.8	64.0/67.8/67.8
Hip Room (in.) Front/Middle/Rear	HP	64.9/50.9/50.9	64.9/50.9/50.9	64.9/50.9/50.9	64.9/50.9/50.9
Load Floor Length (in.) w/Front/Middle/Rear Seats	LFL	88.9/51.4/24.1	98.9/61.4/34.1	88.9/51.4/24.1	98.9/61.4/34.1
Interior Height (in.)	IH	47.5	47.5	47.5	47.5
Interior Width Between Wheelhousings (in.)	IWW	51.6	51.6	51.6	51.6
Cargo Volume (cu. ft.) w/Front/Middle/Rear Seats	CV	151.8/85.8/22.7	170.4/104.4/41.3	151.8/85.8/22.7	170.4/104.4/41.3
FUEL TANK					
Std. Tank Nominal (gal.)		27.0	27.0	27.0	27.0
Location of Tank		Between Frame Rails Forward of Rear Axle	Between Frame Rails Forward of Rear Axle	Between Frame Rails Forward of Rear Axle	Between Frame Rails Forward of Rear Axle
Location of Filler		Left Side	Left Side	Left Side	Left Side

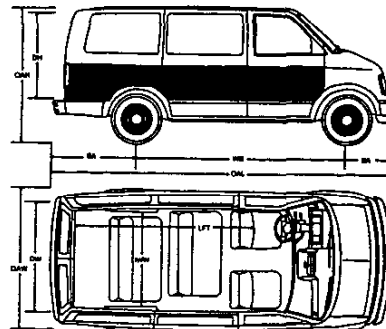
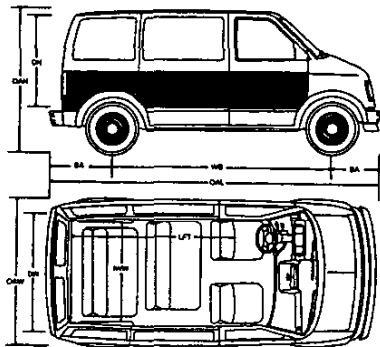

OPTIONS

KEY: S - Standard
O - Optional
— Not Available

1. ASTRO PASSENGER VAN (CM10906)
2. ASTRO EXTENDED PASSENGER VAN (CM11006)
3. ASTRO AWD PASSENGER VAN (CL10906)
4. ASTRO AWD EXTENDED PASSENGER VAN (CL11006)

NOTE: Refer to Dealer Order Guide for updated option availability.

				MODELS			
OPTION		CODE	DESCRIPTION	2-WHEEL DRIVE		ALL-WHEEL DRIVE	
			RESTRICTIONS	1	2	3	4
AIR CONDITIONING							
Front	C60	w/o V02 Cooling	Incls V01 Cooling	O	O	O	O
Front and Rear	C69	Incl w/C69 Front and Rear Air		O	O	O	O
		Incls C60 Front Air		O	O	O	O
AXLE, REAR		G80	Locking Differential	O	O	O	O
			N/A with FE3 or BYP Sport Pkg				
BUMPER EQUIPMENT							
	VE5	Front and Rear Chromed w/Rub Strip	N/A BYP Sport Pkg	O	O	O	O
	VE6	Painted Front and Rear w/Color Keyed End Caps	Incl w/YC6, YC7 or BYP Sport Pkg	O	O	O	O
CARRIER LUGGAGE		V54	Black	O	O	O	O
COLD CLIMATE PACKAGE		V10	Incls Engine Block Heater and Coolant Protection	O	O	O	O
CONSOLE, ROOF		DK6		O	O	O	O
			Reqs TR9 Lighting				
CONVENIENCE GROUP		ZQ2	Incls Power Windows and Power Door Locks	O	O	O	O
	ZQ3	Incls Comfortilt Steering and Electronic Speed Control		O	O	O	O
COOLING SYSTEM							
Engine Oil Cooler	KC4	Incl w/Z82 Trailing	Reqs V01 or V02 Cooling	O	O	O	O
Radiator	V01	Incl w/C60 or C69 Air	N/A V02 Cooling	O	O	O	O
H.D. Radiator and Transmission Oil	V02	Incl w/Z82 Trailing		O	O	O	O
DOOR LOCK SYSTEM, POWER		AU3	Incl w/ZQ2 Conv Pkg	O	O	O	O
ENGINES			(See Powertrains)				
4.3-liter, EFI V6	LB4			S	S	S	S
4.3-liter EFI V6 H.O.	LU2			O	O	—	—
GLASS ARRANGEMENTS		ZW6	Complete Body	O	O	O	O
			N/A CM10906 with BYP Sport Pkg				
GLASS TINTING							
Deep Tinted	AJ1	Incl w/YC7 LT		O	O	O	O
HEATER		C36	Rear	O	O	O	O
INSTRUMENTATION, ELECTRONIC		U52		O	O	O	O
LIGHTING, AUXILIARY		TR9	Incl w/YC6 or YC7. Incls Front and Rear Dome and Reading Lamps, Courtesy Light Switches on all Doors, Front/Rear Stepwell Lights and Glove Box Light.	O	O	O	O
LUXURY PACKAGE (CL)		YC6	(See Trim Level Section)	O	O	O	O
LUXURY TOURING PACKAGE (LT)		YC7	(See Trim Level Section)	O	O	O	O
MIRRORS							
Exterior, Below-Eye-Line Type	D44	Black L.H. 5.0" x 8.5" R.H. 5 1/4" x 9"		O	O	O	O
Exterior, Electric Remote	D48	L.H. 5.0" x 8.5" R.H. 5 1/4" x 9"		O	O	O	O
PAINT, EXTERIOR			(See Color and Trim)				
Solid	ZY1	Solid		S	S	S	S
Special Two-Tone	ZY3	w/YC7LT Incls Body Side Molding		O	O	O	O
Deluxe Two-Tone	ZY4	Incls Body Side Molding and Body Striping Reqs VE5 Bumper w/o YC6		O	O	O	O
Custom Two-Tone	ZY6	Incls Body Side Molding Reqs VE5/VE6 Bumper		O	O	O	O
RADIO EQUIPMENT							
Electronically-Tuned AM/FM Stereo Radio w/Seek-Scan and Digital Clock	UM7	14 Presets, Digital Display, two 6" ERS Front Speakers, two 6" ERS Rear Speakers, two 4" Rear Speakers, 33 Watts Total Power Output.		O	O	O	O
Electronically-Tuned AM/FM Stereo Radio w/Seek-Scan, Stereo Cassette Tape and Digital Clock	UM6	14 Presets, Digital Display, two 6" ERS Front Speakers, two 6" ERS Rear Speakers, 33 Watts Total Power Output.		O	O	O	O
Electronically-Tuned AM Stereo/FM Stereo Radio w/Seek-Scan, Stereo Cassette Tape with Search and Repeat, Graphic Equalizer and Digital Clock	UX1	14 Presets, Digital Display, two 6" ERS Front Speakers, two 6" ERS Rear Speakers, two 4" Rear Speakers, 33 Watts Total Power Output		O	O	O	O
Radio Delete	UL5			O	O	O	O

ASTRO PASSENGER VAN

KEY: S - Standard
 O - Optional
 — Not Available

1. ASTRO PASSENGER VAN (CM10906)
2. ASTRO EXTENDED PASSENGER VAN (CM11006)
3. ASTRO AWD PASSENGER VAN (CL10906)
4. ASTRO AWD EXTENDED PASSENGER VAN (CL11006)

NOTE: Refer to Dealer Order Guide for updated option availability.

		MODELS				
		2-WHEEL DRIVE		ALL-WHEEL DRIVE		
		1	2	3	4	
SEATING ARRANGEMENTS						
5 Person Seating	ZP5	2 Front High Back Buckets and Standard removable 3-Passenger Bench	S	S	S	S
7 Person Seating	ZP7	4 High Back Bucket Seats and a removable 3-Passenger Bench; Incls A78 Seat Back Recliner	O	O	O	O
8 Person Seating	ZP8	2 High Back Bucket Seats and Two removable 3-Passenger Bench Seats; YC7 LT Adds Reclining Seat Backs and Split Bench Seats	O	O	O	O
SEAT BACK RECLINER AND DUAL ARMRESTS	A78	Incl w/ZP7 Seating; or YC7 LT	O	O	O	O
SEAT, 6-WAY POWER, DRIVER	AC3		O	O	O	O
SPORT PACKAGE	BYP	Incls Air Dam w/Fog Lamps, FE3 Sport Suspension, Luxury Sport Steering Wheel, Color Keyed Front & Rear Bumpers and a Wide Black Body Side Molding w/Red Insert and Grille w/Red Striping	O	O	—	—
STOWAGE COMPARTMENT	BA8	Drawer-type, non-locking type beneath front passenger seat	O	O	O	O
SUSPENSION, SPORT	FE3	Incls ZJ7 Wheels, QWT P245/60R15 White Outlined Lettered Tires, Rear Stabilizer & Front & Rear Gas Shocks Incl w/BYP Sport Pkg	O	O	—	—
TIRE EQUIPMENT		(See Wheels and Tires for Details)				
P205/75R15	QCE		S	—	S	—
P205/75R15	QCF		O	—	O	—
P205/75R15	QCG		O	—	O	—
P215/75R15	QCU		—	S	O	S
P215/75R15	QCV		—	O	O	O
P215/75R15	QCW		—	O	O	O
P245/60R15	QWT		O	O	—	—
TRAILERING SPECIAL EQUIPMENT						
Heavy-Duty	Z82	Incls Trailering Hitch and Wiring Harness; Incls V02 and KC4 Engine Oil Cooler and Heavy-Duty Flasher	O	O	O	O
Light-Duty	Z72	Incls Trailer Hitch and Wiring Harness	O	O	O	O
TRANSMISSIONS		(See Powertrains)				
4-Speed Automatic w/Overdrive	MX0		S	S	S	S
WHEELS						
Aluminum	PF3	On YC7 LT Color-Keyed	O	O	O	O
Rally	ZJ7	Incl w/BYP Sports Pkg, YC6, YC7 or FE3. Incls Special Hub Caps and Trim Rings	O	O	O	O

SOLID COLORS

(ZY1)

WITHOUT LUXURY TOURING PACKAGE

Solid paint (ZY1) is standard on all models. All painted areas of the body and front end sheet metal, including the bumpers, are the same color. Below are the interior trim color and exterior paint combinations recommended by Chevrolet, however any available interior trim color may be ordered. For further information, refer to Seats and Interior Trim pages as well as the Ordering Guide.

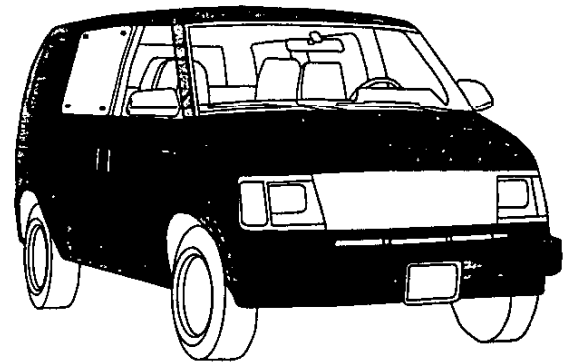

KEY: — Not Available ●—Recommended Blank—Available WHEEL COLOR LEGEND: S - Silver, G - Gold, B - Lt. Blue, W - White.

EXTERIOR COLORS		STRIPE COLORS	INTERIOR COLORS				WHEEL COLORS	
COLOR 1	COLOR 2		Blue	Garnet	Saddle	Gray	Aluminum	Rally
10 Ivory White	10	—	●				W	S
	10	—		●			W	S
	10	—			●		W	G
	10	—				●	W	S
15 Sterling Silver Met.	15	—	●	●		●	S	S
16 Fieldstone Gray Met.	16	—		●		●	S	S
27 Smoke Blue Met.	27	—	●			●	B	S
33 Mojave Beige	33	—		●	●		G	G
34 Sunset Gold Met.	34	—			●		G	G
41 Onyx Black	41	—		●		●	S	S
	41	—			●		G	G
75 Deep Red Met.	75	—		●		●	S	S
76 Burnt Red Met.	76	—		●	●	●	S	S
98 Midnight Blue Met.	98	—	●			●	S	S

WITH LUXURY TOURING PACKAGE (YC7) ONLY

(Includes Decal Striping)

Below are the interior trim color and exterior paint combinations recommended by Chevrolet. They are the only available interior and exterior combinations allowed. For further information, refer to Seats and Interior Trim pages as well as the Ordering Guide.

KEY: — Not Available ●—Recommended WHEEL COLOR LEGEND: S - Silver, B - Lt. Blue

EXTERIOR COLORS		STRIPE COLORS	INTERIOR COLORS				WHEEL COLORS	
COLOR 1	COLOR 2		Blue	Garnet	Saddle	Gray	Aluminum	Rally
30 Catalina Blue Met.	30	Lt. Blue/Med. Blue	●	—	—	—	B	S
97 Slate Met.	97	Lt. Gray/Dk. Gray	—	—	—	●	S	S

WITH BYP ASTRO GT SPORT PACKAGE

Below are the interior trim color and exterior paint combinations recommended by Chevrolet, however any available interior trim color may be ordered. For further information, refer to Seats and Interior Trim pages as well as the Ordering Guide.

KEY: — Not Available ●—Recommended Blank—Available WHEEL COLOR LEGEND: S - Silver, B - Lt. Blue, G - Gold, W - White

EXTERIOR COLORS		STRIPE COLORS	INTERIOR COLORS				WHEEL COLORS	
COLOR 1	COLOR 2		Blue	Garnet	Saddle	Gray	Aluminum	Rally
10 Ivory White	10	—				●	W	S
15 Sterling Silver Met.	15	—				●	S	S
27 Smoke Blue Met.	27	—	●				B	S
34 Sunset Gold Met.	34	—			●		G	G
41 Onyx Black	41	—		●		●	S	S
75 Deep Red Met.	75	—		●			S	S

SPECIAL TWO-TONE

(ZY3) (Includes Decal Striping and Body Side Molding)

Special two-tone paint (ZY3) is available with the Luxury Touring Package (YC7) only. It includes a dual color decal stripe and black body side molding. Color code 1 is applied to the areas above the belt styling crease line. Color code 2 is applied to the areas below the belt styling crease line. Below are the interior trim color and exterior paint combinations recommended by Chevrolet. They are the only available interior and exterior combinations allowed. For further information, refer to Seats and Interior Trim pages as well as the Ordering Guide.

WITH LUXURY TOURING PACKAGE (YC7) ONLY

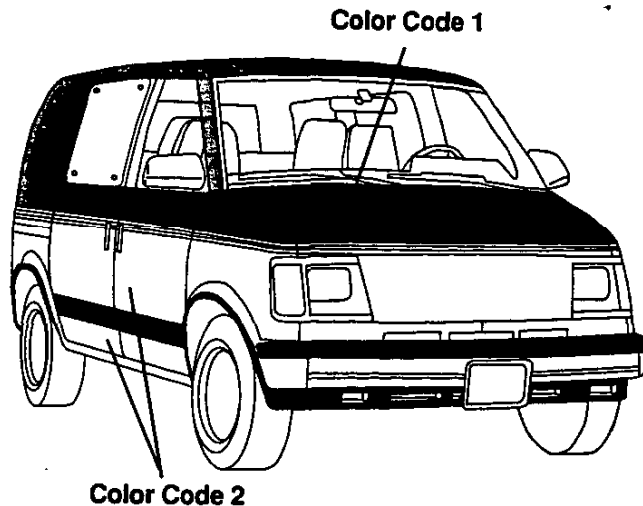

KEY: — Not Available ● Recommended WHEEL COLOR LEGEND: S - Silver, B - Lt. Blue

EXTERIOR COLORS		STRIPE COLORS	INTERIOR COLORS		WHEEL COLORS	
COLOR 1	COLOR 2		Blue	Gray	Aluminum	Rally
16 Fieldstone Gray Met.	97 Slate Met.	Lt. Gray/Dk. Gray	—	●	S	S
27 Smoke Blue Met.	30 Catalina Blue Met.	Lt. Blue/Med. Blue	●	—	B	S

DELUXE TWO-TONE

(ZY4)

Deluxe two-tone paint (ZY4) is available on all models (except Astro LT). Color code 1 is applied to the areas above the decal striping and below the bodyside molding. Color code 2 is applied to the area in between bodyside molding and decal. Below are the interior trim color and exterior paint combinations recommended by Chevrolet. The only available color code 1/color code 2 exterior color combinations are those shown in the chart below, however, any available interior trim color may be ordered. For further information refer to Seats and Interior Trim pages as well as the Ordering Guide.

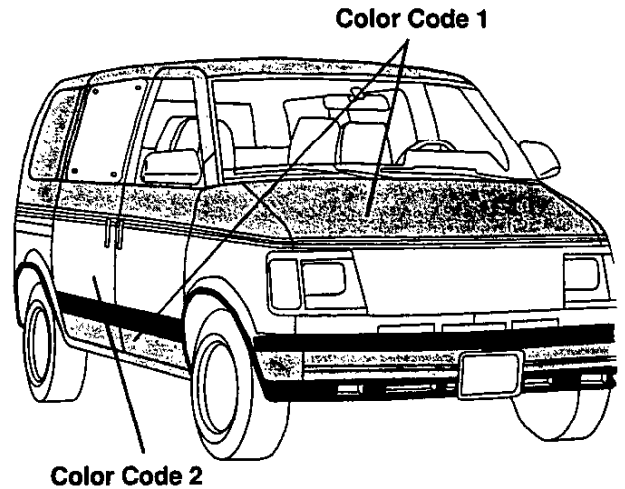

KEY: ●—Recommended Blank—Available WHEEL COLOR LEGEND: S - Silver, G - Gold, B - Lt. Blue

EXTERIOR COLORS		STRIPE COLORS	INTERIOR COLORS				WHEEL COLORS	
COLOR 1	COLOR 2		Blue	Garnet	Saddle	Gray	Aluminum	Rally
10 Ivory White	16 Fieldstone Gray Met.	Black/Red/Black				●	S	S
	34 Sunset Gold Met.	Black/Orange/Black			●		G	G
	98 Midnight Blue Met.	Silver/Blue/Silver	●				S	S
15 Sterling Silver Met.	16 Fieldstone Gray Met.	Black/Red/Black		●		●	S	S
	76 Burnt Red Met.	Black/Red/Black		●		●	S	S
	98 Midnight Blue Met.	Silver/Blue/Silver	●				S	S
16 Fieldstone Gray Met.	15 Sterling Silver Met.	Black/Red/Black		●		●	S	S
27 Smoke Blue Met.	98 Midnight Blue Met.	Silver/Blue/Silver	●				B	S
33 Mojave Beige	34 Sunset Gold Met.	Black/Gold/Black		●	●		G	G
34 Sunset Gold Met.	41 Onyx Black	Black/Orange/Black			●		G	G
41 Onyx Black	15 Sterling Silver Met.	Black/Red/Black		●		●	S	S
	16 Fieldstone Gray Met.	Silver/Red/Silver		●		●	S	S
	34 Sunset Gold Met.	Black/Orange/Black			●		G	G
75 Deep Red Met.	15 Sterling Silver Met.	Black/Red/Black		●		●	S	S
	16 Fieldstone Gray Met.	Silver/Red/Silver		●		●	S	S
	76 Burnt Red Met.	Black/Red/Black		●		●	S	S
76 Burnt Red Met.	15 Sterling Silver Met.	Black/Red/Black		●		●	S	S
	16 Fieldstone Gray Met.	Silver/Red/Silver		●		●	S	S
	34 Sunset Gold Met.	Black/Gold/Black		●	●		G	G
98 Midnight Blue Met.	15 Sterling Silver Met.	Silver/Blue/Silver	●			●	S	S

CUSTOM TWO-TONE

(ZY6)
WITHOUT BYP ASTRO GT SPORT PACKAGE

Custom two-tone paint (ZY6) is available on all models (except on Astro LT). Color code 1 is applied to the area above the bodyside molding, and Color code 2 is applied to the areas below the bodyside molding. Below are the interior trim color and exterior paint combinations recommended by Chevrolet. The only available Color code 1/Color code 2 exterior color combinations are those shown in the chart below, however any available interior trim color may be ordered. For further information, refer to Seats and Interior Trim as well as the Order Guide.

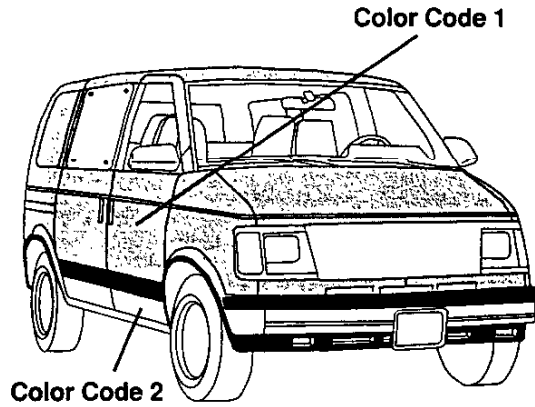

KEY: — Not Available Blank—Available •—Recommended WHEEL COLOR LEGEND: S - Silver, G - Gold, B - Lt. Blue

EXTERIOR COLORS		STRIPES COLORS		INTERIOR COLORS			WHEEL COLORS	
COLOR 1	COLOR 2		Blue	Garnet	Saddle	Gray	Aluminum	Rally
10 Ivory White	16 Fieldstone Gray Met.	—				•	S	S
	34 Sunset Gold Met.	—			•		G	G
	98 Midnight Blue Met.	—	•				S	S
15 Sterling Silver Met.	16 Fieldstone Gray Met.	—		•		•	S	S
	76 Burnt Red Met.	—		•		•	S	S
	98 Midnight Blue Met.	—	•				S	S
16 Fieldstone Gray Met.	15 Sterling Silver Met.	—		•		•	S	S
27 Smoke Blue Met.	98 Midnight Blue Met.	—	•				B	S
33 Mojave Beige	34 Sunset Gold Met.	—		•	•		G	G
34 Sunset Gold Met.	41 Onyx Black	—			•		G	G
41 Onyx Black	15 Sterling Silver Met.	—		•		•	S	S
	16 Fieldstone Gray Met.	—		•		•	S	S
	34 Sunset Gold Met.	—			•		G	G
75 Deep Red Met.	15 Sterling Silver Met.	—		•		•	S	S
	16 Fieldstone Gray Met.	—		•		•	S	S
	76 Burnt Red Met.	—		•		•	S	S
76 Burnt Red Met.	15 Sterling Silver Met.	—		•		•	S	S
	16 Fieldstone Gray Met.	—		•		•	S	S
	34 Sunset Gold Met.	—		•	•		G	G
98 Midnight Blue Met.	15 Sterling Silver Met.	—	•			•	S	S

WITH BYP ASTRO GT SPORT PACKAGE

Below are the interior and exterior paint combinations recommended by Chevrolet, however any available interior trim color may be ordered. For further information, refer to Seats and Interior Trim as well as the Ordering Guide.

KEY: — Not Available Blank—Available •—Recommended WHEEL COLOR LEGEND: S - Silver, G - Gold, B - Lt. Blue, W - White

EXTERIOR COLORS		STRIPES COLORS		INTERIOR COLORS			WHEEL COLORS	
COLOR 1	COLOR 2		Blue	Garnet	Saddle	Gray	Aluminum	Rally
10 Ivory White	41 Onyx Black	—				•	W	S
15 Sterling Silver Met.	41 Onyx Black	—				•	S	S
27 Smoke Blue Met.	41 Onyx Black	—	•				B	S
34 Sunset Gold Met.	41 Onyx Black	—			•		G	G
75 Deep Red Met.	41 Onyx Black	—		•			S	S