

ORIGINAL

1981

# SUBURBAN

## SUBURBAN MODEL SELECTOR

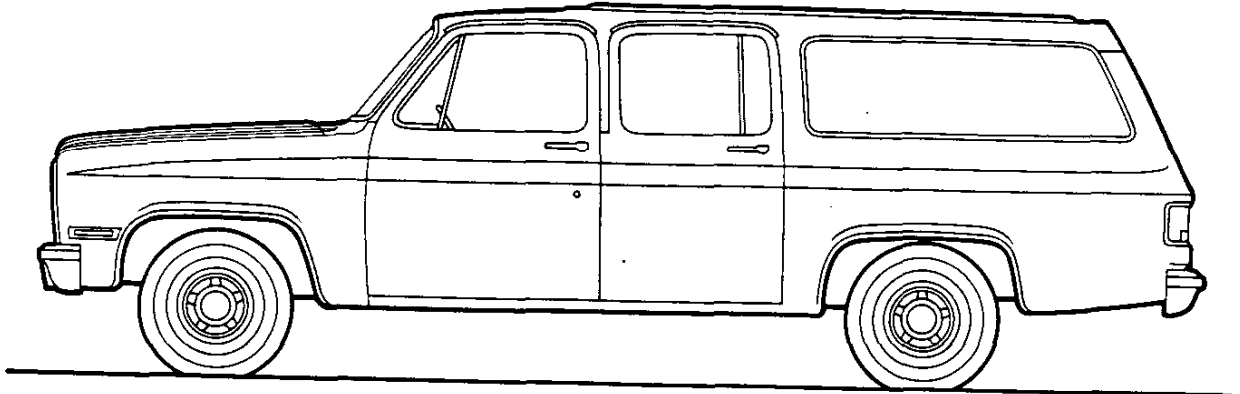

Series	Model Number	Body Ordering Code	
		Panel Rear Doors	Endgate
<b>C10</b>	CC10906	ZW9	E55
<b>C20</b>	CC20906	ZW9	E55
<b>K10</b> (4-Wheel Drive)	CK10906	ZW9	E55
<b>K20</b> (4-Wheel Drive)	CK20906	ZW9	E55

# SUBURBAN—Conventional

## STANDARD SPECIFICATIONS

(See Blue Tab Section for Specification Details)

Series	C10	C20
<b>Engine</b>		
Base Equip. ....	■ 5.0 Liter, 305 4-bbl V8	5.7 Liter, 350 4-bbl. V8
Clutch .....	12", 150 sq. in.	
Air Filter .....	Oiled-paper Element	
Oil Filter .....	Throwaway Type	
Exhaust System .....	*Single; Aluminized	
Emission Control Systems .....	See Engine & Cooling Section for specific model applications	
<b>Suspension, Front</b> .....	Independent; Coil Springs	
Capacity .....	3250 lb.	3800 lb.
Springs @ Ground .....	1625 lb. ea.	1900 lb. ea.
Shock Absorbers .....	25mm dia.	32mm dia.
Stabilizer Bar .....	—	1.06" dia.
<b>Suspension, Rear</b> .....	Salisbury Axle; Hypoid Drive; Two-stage Multi-leaf Springs	
Axle Capacity .....	3750 lb.	6000 lb.
Axle Ratio .....	2.73	3.42
Springs, Main @ Ground .....	2000 lb. ea.	3000 lb. ea.
Shock Absorbers .....	25mm dia.	32mm dia.
<b>Brakes</b> .....	Hydraulic; Self-adjusting	
Front .....	Disc; 11.86" Rotor	Disc; 12.5" Rotor
Rear .....	Drum; 11.15" x 2.75"	Drum; 13.0" x 2.5"
Booster .....	Dual Diaphragm	
Parking .....	Cable to Rear Wheels	
<b>Electrical</b> .....	12 Volt; Negative Ground	
Battery—Freedom Type .....	370 CCA♦ @ 0°F.	
—Reserve Capacity .....	80 min. @ 80°F.	
Delcotron Generator .....	37 amp.	
<b>Frame</b> .....	Carbon Steel; 36,39,000 psi	
Section Modulus .....	3.10	3.88
<b>Fuel Tank (nominal capacity)</b> .....	25 gal.	
<b>Steering Gear Type</b> .....	Manual; Recirculating Ball Gear	
Linkage .....	Parallelogram	
<b>Transmission</b> .....	4-Speed Manual	
Shift Location .....	Floor	
<b>Tires</b> .....	(5) P235/75R15	Fr. (2) 9.50-16.5D (8PR) Rr. (2) 9.50-16.5E (10PR)
<b>Wheels</b> .....	(5) Disc 15" x 6"	(4) Disc 16.5" x 6.75"

■ Standard engine not available for registration in the State of California; see Power Teams Chart.

\*Dual tail pipe on C10 model.

♦CCA-Cold Cranking Amps

# SUBURBAN—4-Wheel Drive

## STANDARD SPECIFICATIONS

(See Blue Tab Section for Specification Details)

Series	K10	K20
<b>Engine</b>		
<b>Base Equip.</b> .....	5.7 Liter, 350 4-bbl. V8	
<b>Clutch</b> .....	12"; 150 sq. in.	
<b>Air Filter</b> .....	Oiled-paper Element	
<b>Oil Filter</b> .....	Throwaway Type	
<b>Exhaust System</b> .....	*Single; Aluminized	
<b>Emission Control Systems</b> .....	See Engine & Cooling Section for specific model applications	
<b>Suspension, Front</b> .....	Salisbury Axle, Hypoid Drive; Single-stage 2-leaf Springs	
<b>Capacity</b> .....	3600 lb.	3800 lb.
<b>Axle Ratio</b> .....	3.42	3.73
<b>Springs @ Ground</b> .....	1850 lb. ea.	1850 lb. ea.
<b>Shock Absorbers</b> .....	25mm dia.	32mm dia.
<b>Stabilizer Bar</b> .....	1.25" dia.	1.25" dia.
<b>Hubs—Automatic Locking</b> .....	Standard	Standard
<b>Suspension, Rear</b> .....	Salisbury Axle, Hypoid Drive; Two-stage Multi-leaf Springs	
<b>Axle Capacity</b> .....	4000 lb.	6000 lb.
<b>Axle Ratio</b> .....	3.42	3.73
<b>Springs @ Ground</b> .....	2000 lb. ea.	3000 lb. ea.
<b>Shock Absorbers</b> .....	25mm dia.	32mm dia.
<b>Brakes</b> .....	Hydraulic; Self-adjusting	
<b>Front</b> .....	Disc; 11.86" Rotor	Disc; 12.5" Rotor
<b>Rear</b> .....	Drum; 11.15" x 2.75"	Drum; 13" x 2.5"
<b>Booster</b> .....	Dual Diaphragm	
<b>Parking</b> .....	Cable to Rear Wheels	
<b>Electrical</b> .....	12 Volt; Negative Ground	
<b>Battery—Freedom Type</b> .....	370 CCA ♦ @ 0°F.	
<b>—Reserve Capacity</b> .....	80 min. @ 80°F.	
<b>Delcotron Generator</b> .....	37 amp.	
<b>Frame</b> .....	Carbon Steel; 36,- 39,000 psi	
<b>Section Modulus</b> .....	3.57	3.88
<b>Fuel Tank (nominal capacity)</b> .....	25 gal.	
<b>Steering Gear Type</b> .....	Integral Power	
<b>Transmission</b> .....	4-Speed Manual	
<b>Shift Location</b> .....	Floor	
<b>Transfer Case</b> .....	New Process 208 2-Speed	
<b>Shift Lever</b> .....	Single Lever	
<b>Tires</b> .....	(5) P215/75R15	Fr. (2) 9.50-16.5D(8PR) Rr. (2) 9.50-16.5E(10PR)
<b>Wheels</b> .....	(5) Disc 15" x 6"	(4) Disc 16.5" x 6.75"

\*Dual tail pipe on K10 model.  
♦CCA-Cold Cranking Amps.

# SUBURBAN

Body Ordering Codes:  
 Panel Rear Doors—ZW9  
 Endgate—E55†

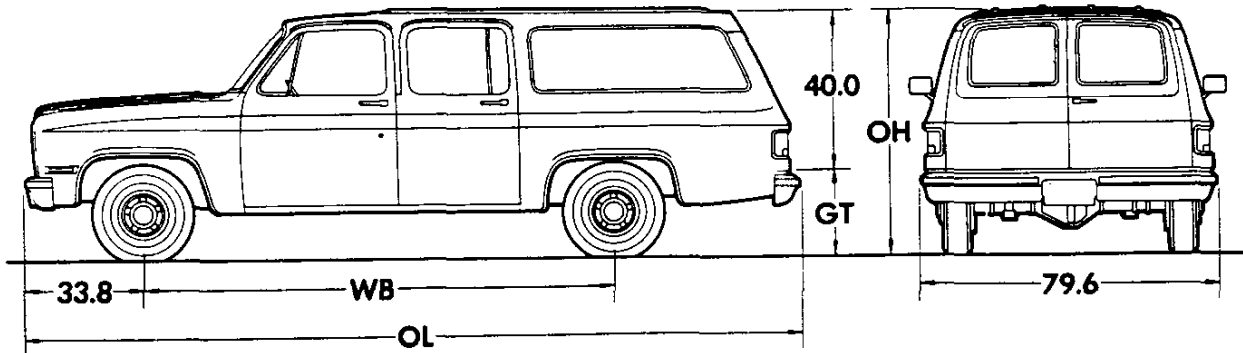

Capacity—143.5 cu ft  
 Load Floor Area—40 sq ft

Series	Ground Clearance (in)*	
	Front	Rear
C10	7.5	7.2
C20	8	7.8
K10	8.7	7.2
K20	8.8	7.8

Model	Engine No. Cyl.	Dimensions (in)*				†Curb Weight (lb)			†Model Weight (lb)*		
		WB	OL	OH	GT	Front	Rear	Total	Front	Rear	Total

### C10 SERIES

CC10906	8	129.5	219.1	72.0	28.8	2100	2289	4389	2343	2496	4839
---------	---	-------	-------	------	------	------	------	------	------	------	------

### C20 SERIES

CC20906	8	129.5	219.1	72.7	29.5	2368	2329	4697	2611	2536	5147
---------	---	-------	-------	------	------	------	------	------	------	------	------

### K10 SERIES

CK10906	8	129.5	219.1	73.8	30.5	2391	2273	4664	2634	2480	5114
---------	---	-------	-------	------	------	------	------	------	------	------	------

### K20 SERIES

CK20906	8	129.5	219.1	76.1	33.6	2494	2489	4983	2737	2696	5433
---------	---	-------	-------	------	------	------	------	------	------	------	------

\*Dimensions with standard equipment, unloaded.

\*Model Weight includes Curb Weight plus occupants (standard seating capacity x 150 lb). Total Model Weight may vary as much as ±150 lbs. to allow for production build variation.

†Curb Weights and Model Weights shown are for models with ZW9 Panel Rear Doors. For models with E55 Endgate, weights must be adjusted as follows: Front -22 lb.; Rear +60 lb.; Total added weight 38 lb.

# SUBURBAN

## POWER TEAMS

### ALL STATES EXCEPT CALIFORNIA

ENGINE	TRANSMISSIONS BY RPO NUMBER		♦ AXLE RATIOS BY RPO NUMBER				*GVWR
	4-SP	AUTO	2.73	3.08	3.42	3.73	

#### C10 SERIES

LE9 V8 5.0 Liter (305-4 BBL) w/ESC	MM4	MX1	GQ1	GU4	-	-	6100
	MM4	-	GQ1	GU4	-	-	6800
	-	MX1	-	GQ1	-	-	6800
LS9 V8 5.7 Liter (350-4 BBL)	MM4	-	-	GQ1	GU6	-	6100
	-	MX1	GQ1	GU4	-	+GT4	6100
	-	MX1	-	-	-	●G84	6100
	MM4	-	-	GQ1	GU6	-	6800
	-	MX1	-	GQ1	-	+GT4	6800
	-	MX1	-	-	-	●G84	6800

#### K10 SERIES

LS9 V8 5.7 Liter (350-4 BBL)	MM4	-	-	-	GQ1	GT4	6100	
	-	MX1	-	-	GQ1	GU6	+GT4	6100
	-	MX1	-	-	-	●G84	6100	
	MM4	-	-	-	GQ1	GT4	6800	
	-	MX1	-	-	GQ1	GU6	+GT4	6800
	-	MX1	-	-	-	●G84	6800	

ENGINE	TRANSMISSIONS BY RPO NUMBER		♦ AXLE RATIOS BY RPO NUMBER					*GVWR
	4-SP	AUTO	■ 3.21	3.42	3.73	4.10	4.56	

#### C20 SERIES

LT9 V8 5.7 Liter (350-4BBL)	MM4	-	-	GQ1	GT4	-	-	8600
	-	MX1	-	-	-	GQ1	HC4	8600
LE8 V8 7.4 Liter (454-4 BBL)	-	MX1	■GQ1	-	GT4	GT5	-	8600

#### K20 SERIES

LT9 V8 5.7 Liter (350-4 BBL)	MM4	-	-	-	GQ1	GT5	-	8600
	-	MX1	-	-	-	GQ1	-	8600

♦ Locking Differential rear axle also available; GQ1 indicates standard axle ratio.

● High altitude Axle (G84) - For high altitude application only.

\* For Required Tire Capacity and Chassis Equipment see **GVWR SELECTOR**.

■ Locking Differential rear axle not available. + Requires Trailering Special (Z82).

# SUBURBAN

## POWER TEAMS

### CALIFORNIA ONLY

ENGINE	TRANSMISSIONS BY RPO NUMBER		♦ AXLE RATIOS BY RPO NUMBER				★GVWR
	4-SP	AUTO	2.73	3.08	3.42	3.73	

#### C10 SERIES

LS9 V8 5.7 Liter (350-4 BBL)	—	MX1	—	GQ1	GU6	—	6100
	—	MX1	—	GQ1	GU6	—	6800

#### K10 SERIES

LS9 V8 5.7 Liter (350-4 BBL)	—	MX1	—	GQ1	GU6	—	6100
	—	MX1	—	GQ1	GU6	—	6800

ENGINE	TRANSMISSIONS BY RPO NUMBER		♦ AXLE RATIOS BY RPO NUMBER					★GVWR
	4-SP	AUTO	■ 3.21	3.42	3.73	4.10	4.56	

#### C20 SERIES

LT9 V8 5.7 Liter (350-4BBL)	MM4	—	—	GQ1	GT4	—	—	8600
	—	MX1	—	—	—	GQ1	HC4	8600
LE8 V8 7.4 Liter (454-4 BBL)	—	MX1	■GQ1	—	GT4	GT5	—	8600

#### K20 SERIES

LT9 V8 5.7 Liter (350-4 BBL)	MM4	—	—	—	GQ1	GT5	—	8600
	—	MX1	—	—	—	GQ1	—	8600

- ♦ Locking Differential rear axle also available; GQ1 indicates standard axle ratio.
- High altitude Axle (G84) – For high altitude application only.
- ★ For Required Tire Capacity and Chassis Equipment see **GVWR SELECTOR**.
- Locking Differential rear axle not available. † Requires Trailering Special (Z82).

## SUBURBAN

### GVWR SELECTOR— ALL STATES

GVW Rating (lbs)	†GAWR (lbs)		Minimum Equipment Required for GVW Rating		
	Front	Rear	Tire Capacity (lbs ea)		Chassis Equipment
			Front	Rear	

#### C10 SERIES

■ 6100	3250	3686	1843	1843	Standard
■ 6800	3250	3750	1910	1910	Center Seat (AT5) and Stabilizer Bar (F59); or Center and Rear Seats (AS3)

#### K10 SERIES

■ 6100	3166	3166	1583	1583	Standard
■ 6800	3600	3686	1843	1843	

†GAWR's shown are the maximum for each axle with equipment listed. Other GAWR's are available, and they are determined as the minimum capacity of either axle, springs or tires.

■ Center seat (AT5) available on all GVWRs; Center and Rear seats (AS3) available on 6800 GVWR only.

### FRONT AND REAR TIRE AVAILABILITY CHART— ALL STATES

#### C-K10 SERIES

**Spare tire to match either front or rear tires must be ordered  
K10 models require matching front and rear tread**

Description	Capacity (lbs ea)	Highway		On-Off Road		Spare
		Front	Rear	*Front	Rear	
<b>TUBELESS</b>						
#P215/75R15 (Base K10) Steel Belted Radial	1583	XKT	YKT	—	—	ZKT
#P215/75R15 Whitewall Steel Belted Radial	1583	XKU	YKU	—	—	ZKU
P235/75R15 (Base C10) Steel Belted Radial	1843	XBD	YBD	—	—	ZBD
P235/75R15 Whitewall Steel Belted Radial	1843	—	—	*XQJ	YQJ	ZQJ
P235/75R15 XL Steel Belted Radial	C10 1910 K10 1984	XBJ	YBJ	—	—	ZBI
P235/75R15 XL Steel Belted Radial	C10 1910 K10 1984	XPR	YPR	—	—	ZPR
P235/75R15 Whitewall XL Steel Belted Radial	C10 1910 K10 1984	XPR	YPR	—	—	ZPR
P235/75R15 Whitewall XL Steel Belted Radial	C10 1910 K10 1984	XPW	YPW	—	—	ZPW
P235/75R15 Whitewall XL Steel Belted Radial	C10 1910 K10 1984	XPW	YPW	—	—	ZPW

\*On-Off road front tires available on K10 models only.

#K10 models only.

## SUBURBAN GVWR SELECTOR—ALL STATES

GVW Rating (lbs)	+GAWR (lbs)		Minimum Equipment Required for GVW Rating		
			Tire Capacity (lbs ea)		Chassis Equipment
	Front	Rear	Front	Rear	

### C20 SERIES

<b>8600</b>	3800	6000	2780	3170	Standard
-------------	------	------	------	------	----------

### K20 SERIES

<b>8600</b>	3700	6000	2780	3170	Standard
-------------	------	------	------	------	----------

+GAWR's shown are the maximum for each axle with equipment listed. Other GAWR's are available, and they are determined as the minimum capacity of either axle, springs or tires.

## FRONT AND REAR TIRE AVAILABILITY CHART—ALL STATES

### C-K20 SERIES

Spare tire to match either front or rear tires is available at extra cost  
K20 models require matching front and rear tread

Description	Capacity (lbs ea)	Highway		On-Off Road		Spare
		Front	Rear	*Front	Rear	
<b>TUBELESS</b>						
<b>9.50-16.5D</b> Polyester	2780	XUF	—	—	—	ZUF
<b>9.50-16.5E</b> Polyester	3170	—	YUC	—	YUH	ZUH
<b>9.50-16.5E</b> Polyester	3170	XUC	YUC	—	—	ZUC
<b>9.50-16.5E</b>	3170	—	—	*XUH	YUH	ZUH

\*On-Off road front tires available on K20 models only.

## ENGINE RATINGS ALL STATES EXCEPT CALIFORNIA

SAE Net Ratings @ 85°F	*5.0 Liter 305 4-bbl V8	*5.7 Liter 350 4-bbl V8	**5.7 Liter 350 4-bbl V8	**7.4 Liter 454 4-bbl V8
<b>Net Horsepower</b> .....	160 @ 4400 rpm	165 @ 3800 rpm	160 @ 3800 rpm	210 @ 3800 rpm
<b>Net Torque, lb-ft</b> .....	235 @ 2000 rpm	275 @ 1600 rpm	250 @ 2800 rpm	340 @ 2800 rpm

\*Engine with Light or Medium Duty Emissions (w/GVWR up to 8500 lb.)

\*\*Engine with Heavy Duty Emissions (w/GVWR over 8500 lb.)

## CALIFORNIA ONLY

SAE Net Rating @ 85°F	*5.7 Liter 350 4-bbl V8	**5.7 Liter 350 4-bbl V8	**7.4 Liter 454 4-bbl V8
<b>Net Horsepower</b> .....	150 @ 3600 rpm	155 @ 4000 rpm	210 @ 3800 rpm
<b>Net Torque, lb-ft</b> .....	255 @ 1600 rpm	240 @ 2600 rpm	340 @ 2800 rpm

\*Engine with Light or Medium Duty Emissions (w/GVWR up to 8500 lb.)

\*\*Engine with Heavy Duty Emissions (w/GVWR over 8500 lb.)



## SUBURBAN

### 1981 VEHICLES WITH STANDARD EQUIPMENT

Prices shown are effective with vehicles produced on or after January 5, 1981.

Description	Model Number	Body Code	Wheel Base	Factory D&H(a)	List Price	Mfr's Sgt'd Retail Price*	Group Number
◆ 8-Cylinder 5.0 Liter (305 Cu. In.) 4 BBL Engine-Engine Ordering Code LE9							
<b>C10 Series 2-Wheel Drive</b>							
Panel Doors.....	CC10906	ZW9	129.5"	15.55	8470.00	8485.55	15
Tailgate.....	CC10906	E55	129.5"	15.55	8501.00	8516.55	15
◆ 8-Cylinder 5.7 Liter (350 Cu. In.) 4 BBL Engine-Engine Ordering Code LS9							
<b>K10 Series 4-Wheel Drive</b>							
Panel Doors.....	CK10906	ZW9	129.5"	13.75	9714.00	9727.75	16
Tailgate.....	CK10906	E55	129.5"	13.75	9745.00	9758.75	16
◆ 8-Cylinder 5.7 Liter (350 Cu. In.) 4 BBL Engine-Engine Ordering Code LT9							
<b>C20 Series 2-Wheel Drive</b>							
Panel Doors.....	CC20906	ZW9	129.5"	18.60	8722.00	8740.60	15
Tailgate.....	CC20906	E55	129.5"	18.60	8752.00	8770.60	15
<b>K20 Series 4-Wheel Drive</b>							
Panel Doors.....	CK20906	ZW9	129.5"	18.60	10197.00	10215.60	16
Tailgate.....	CK20906	E55	129.5"	18.60	10227.00	10245.60	16

- \* Manufacturer's Suggested Retail Prices do not include applicable destination charges, state and local taxes, license fees, optional equipment or accessories or special items or services.
- ◆ Refer to Power Team Chart for California Emission Certification Requirements.

### OPTIONS AND ACCESSORIES WHEN INSTALLED BY CHEVROLET

Prices shown are effective with vehicles produced on or after January 5, 1981.

Description	Added Weight (F R)	Option Number	Factory D&H(a)	List Price	Mfr's Suggested Retail Price◇
<b>POWER TEAMS AND AXLES</b>					
(See Power Teams Chart for availability and complete specifications)					
<b>Engines:</b>					
5.7 Liter (350 Cu. In.) 4 BBL V8. C10 series only.....	0 0	LS9		NO ADDITIONAL CHARGE	
7.4 Liter (454 Cu. In.) 4 BBL V8. C20 series only. Available only when N41 Power Steering and UA1 HD Battery.....	177 20	LE8	N.A.	110.00	110.00
<b>Gaseous-Fuel Conversions:</b> See Engine and Cooling Section.					
<b>Transmissions:</b>					
Automatic. C-K20 series includes extra cooling.					
C10 series only.....	-67 12	MX1	N.A.	384.00	384.00
C20 series only.....					
LT9 5.7 Liter 4 BBL V8 Engine.....	-68 2	MX1	N.A.	399.00	399.00
LE8 7.4 Liter 4 BBL V8 Engine.....	0 0	MX1	N.A.	399.00	399.00
K10 Series only with NA5 Standard Emission Requirements.....	-59 11	MX1	N.A.	384.00	384.00
K20 series only.....	-28 4	MX1	N.A.	399.00	399.00
4-Speed Manual. Not available when YF5 California Emission Requirements is specified.....	0 0	MM4		NO ADDITIONAL CHARGE	
<b>Axles, Rear:</b> (See Power Teams Chart for option number selection, availability and complete specifications)					
Optional Ratio.....	0 0		N.A.	26.00	26.00
High Altitude. 3.73 Ratio. C-K10 Series only. Available only when LS9 5.7 Liter 4 BBL V8 Engine and MX1 Automatic Transmission are specified. Not available when YF5 California Emissions or G80 Locking Differential Axle is specified.....	0 0	G84	N.A.	26.00	26.00
<b>Locking Differential.</b>					
C-K10 series only.....	0 3	G80	N.A.	191.00	191.00
C-K20 series only.....	0 5	G80	N.A.	191.00	191.00

- (a) D & H Charges on vehicle and optional equipment include reimbursement to Chevrolet Motor Division for any tax that it has paid, incurred or agreed to pay thereon.
- ◇ State and local taxes not included.

# SUBURBAN

## OPTIONS AND ACCESSORIES WHEN INSTALLED BY CHEVROLET

Prices shown are effective with vehicles produced on or after January 5, 1981.

Description	Added Weight (F R)	Option Number	Factory D&H(a)	List Price	Mfr's Suggested Retail Price◇
<b>MODEL OPTIONS</b>					
<i>(See Interior and Exterior Color Selection Chart)</i>					
<b>Scottsdale:</b> Not available when YE9 Silverado is specified. Includes bright windshield and rear side window moldings, V37 Front and Rear Bumpers, B84 Black Body Side Moldings, turn signal and side marker lamp bezels, bright taillight trim, dual horns, nameplates on front fender and instrument panel, BB5 Headliner, U37 Cigarette Lighter, C91 Dome Lamp with Bright Bezels, bright sill plates and special insulation. Also includes spare tire cover when spare tire is specified. ....					
	15 26	Z62	N.A.	394.00	394.00
<b>Silverado:</b> Available only when custom seats are specified. Includes V37 Front and Rear Bumpers, B96 Wheel Opening Moldings, N31 Custom Steering Wheel, YG3 Deluxe Molding Package, bright taillight trim and rear door or tailgate moldings, bright front turn signal and front side marker lamp bezels, Silverado fender nameplates, bright windshield and rear side window moldings, B30 Carpeting, bright sill plates, plastic door trim panels with storage pockets and bright brushed-finish accents, dual horns, D34 Visor Mirror, B85 Bright Body Side Moldings, V22 Deluxe Front Appearance, Silverado nameplate on instrument panel, U37 Cigarette Lighter, BB5 Headliner, C91 Dome Lamp with Bright Bezels, special insulation, pillar trim panels, Z53 Voltmeter, Temperature, and Oil Pressure Gages. Also includes spare tire cover when spare tire is specified. ....					
	51 60	YE9	N.A.	825.00	825.00

### OTHER OPTIONS

**Air Conditioning: All-Weather.** Not available when V10 Cold Climate Package is specified. Also includes BB5 Headliner. Includes extra cooling and K77 55-Amp Generator.

**Front.** Included when C69 Front and Rear Air Conditioning is specified. Recommended for front seat area cooling only.

Without Z62 Scottsdale or YE9 Silverado.

C10 series only. ....	75 29	C60	N.A.	707.00	707.00
K10 series only. ....	77 28	C60	N.A.	707.00	707.00
C-K20 series only					
Without MX1 Automatic Transmission. ....	77 28	C60	N.A.	707.00	707.00
With MX1 Automatic Transmission. ....	80 27	C60	N.A.	707.00	707.00

With Z62 Scottsdale or YE9 Silverado.

C10 series only. ....	68 10	C60	N.A.	591.00	591.00
K10 series only. ....	70 9	C60	N.A.	591.00	591.00
C-K20 series only					
Without MX1 Automatic Transmission. ....	70 9	C60	N.A.	591.00	591.00
With MX1 Automatic Transmission. ....	80 8	C60	N.A.	591.00	591.00

**Front and Rear.** Rear Interior Roof Mounted. Available only when YE9 Silverado or Z62 Scottsdale is specified. Rear system operates on recirculating air. Includes K81 63-Amp Generator

C10 series only. ....	89 47	C69	N.A.	928.00	928.00
K10 series only. ....	81 65	C69	N.A.	928.00	928.00
K20 series only					
Without MX1 Automatic Transmission. ....	91 65	C69	N.A.	928.00	928.00
With MX1 Automatic Transmission. ....	94 64	C69	N.A.	928.00	928.00

**Appearance, Deluxe Front:** Includes chromed grille and dual rectangular headlamps. Included when YE9 Silverado is specified. ....

	0 0	V22	N.A.	88.00	88.00
<b>Batteries: 12-Volt</b>					
<b>Auxiliary.</b> 465 CCA Delco Freedom. ....	51 -7	TP2	N.A.	101.00	101.00
<b>Heavy-Duty.</b> 465 CCA Delco Freedom. Included when V10 Cold-Climate Package is specified. ....	3 0	UA1	N.A.	40.00	40.00

(a) D & H Charges on vehicle and optional equipment include reimbursement to Chevrolet Motor Division for any tax that it has paid; incurred or agreed to pay thereon.

◇ State and local taxes not included.

# SUBURBAN

## OPTIONS AND ACCESSORIES WHEN INSTALLED BY CHEVROLET

Prices shown are effective with vehicles produced on or after January 5, 1981.

Description	Added Weight (F R)	Option Number	Factory D&H(a)	List Price	Mfr's Suggested Retail Price <sup>◇</sup>
<b>OTHER OPTIONS</b>					
<b>Bumper Equipment:</b>					
<i>Bumpers, Deluxe.</i> Front and Rear. Not available when V31 Bumper Guards are specified. Includes V37 Front and Rear Bumpers and black resilient impact strips					
Without Z62 Scottsdale or YE9 Silverado.....	4 4	VE5	N.A.	96.00	96.00
With Z62 Scottsdale or YE9 Silverado.....	4 4	VE5	N.A.	38.00	38.00
<i>Bumpers, Chromed.</i> Front and Rear. Included when Z62 Scottsdale or YE9 Silverado is specified.....					
	0 0	V37	N.A.	58.00	58.00
<i>Guards, Chromed, Front Bumper.</i> Available only when V37 Front and Rear Bumpers, Z62 Scottsdale or YE9 Silverado is specified					
	10 -2	V31	N.A.	34.00	34.00
<b>Clock, Electric: Quartz Movement.</b> Not available when U16 Tachometer is specified.					
Without YE9 Silverado. Includes Z53 Voltmeter, Temperature and Oil Pressure Gages.....	0 0	U35	N.A.	60.00	60.00
With YE9 Silverado.....	0 0	U35	N.A.	31.00	31.00
<b>Cold-Climate Package:</b> Not available when YF5 California Emissions, C60 Front or C69 Front and Rear Air Conditioning is specified. Includes super heater and defroster, engine block heater and anti-freeze protection to -32 degrees. Includes UA1 HD Battery and K77 55-Amp Generator.					
Without Z82 Trailing Special.....	5 2	V10	N.A.	145.00	145.00
With Z82 Trailing Special.....	5 2	V10	N.A.	98.00	98.00
<b>Coolers:</b> Included when Z82 Trailing Special is specified. Recommended for heavy duty trailering.					
<i>Engine Oil.</i> .....					
	9 -1	KC4	N.A.	95.00	95.00
<i>Transmission Oil, Heavy-Duty.</i> Available only when MX1 Automatic Transmission is specified. C-K10 series also available only when C60 Front or C69 Front and Rear Air Conditioning or V01 HD Radiator is specified. Included when Z82 Trailing Special is specified.....					
	5 -1	V02	N.A.	47.00	47.00
<b>Cooling: Radiator, Heavy-Duty.</b> Not available when C60 Front Air Conditioning or C69 Front and Rear Air Conditioning is specified.					
C-K10 series only.....	8 -1	V01	N.A.	42.00	42.00
C-K20 series only. Also not available when MX1 Automatic Transmission is specified.....	6 -1	V01	N.A.	42.00	42.00
<b>Door Lock System, Power: Side doors only.</b> Included when ZQ2 Operating Convenience Package is specified. Available only when BB5 Headliner, Z62 Scottsdale or YE9 Silverado, C60 Front or C69 Front and Rear Air Conditioning is specified.....					
	3 1	AU3	N.A.	147.00	147.00
<b>Emission Systems: Dealer Note</b> - One of the following emission options must be specified.					
<i>California Emission Requirements:</i> Not available when V10 Cold Climate Package is specified. Available only when LS9 5.7 Liter Engines is specified on C-K10 series. Includes all testing, equipment and /or certification necessary for registration in the State of California (See Power Teams Chart for availability and complete specifications).....					
	0 0	YF5	N.A.	80.00	80.00
<i>Standard Emission Equipment.</i> Not available when YF5 California Emissions are specified.....					
	0 0	NA5	NO ADDITIONAL CHARGE		
<b>Floor Covering:</b>					
<i>Carpeting, Floor and Wheelhouse:</i> Available only when Z62 Scottsdale and AT5 or AS3 Seats are specified.....					
	-4 32	B30	N.A.	111.00	111.00
<i>Mats, Color-Keyed, Front Floor</i> .....	5 2	B32	N.A.	11.00	11.00
<b>Gages:</b>					
<i>Voltmeter, Temperature and Oil Pressure.</i> Included when YE9 Silverado, U35 Electric Clock or U16 Tachometer is specified.					
	1 0	Z53	N.A.	29.00	29.00
<i>Tachometer.</i> Not available when U35 Electric Clock is specified. Includes Z53 Voltmeter, Temperature and Oil Pressure Gages					
Without YE9 Silverado.....	2 0	U16	N.A.	90.00	90.00
With YE9 Silverado.....	1 0	U16	N.A.	61.00	61.00

(a) D & H Charges on vehicle and optional equipment include reimbursement to Chevrolet Motor Division for any tax that it has paid, incurred or agreed to pay thereon.  
<sup>◇</sup> State and local taxes not included.

# SUBURBAN

## OPTIONS AND ACCESSORIES WHEN INSTALLED BY CHEVROLET

Prices shown are effective with vehicles produced on or after January 5, 1981.

Description	Added Weight (F R)	Option Number	Factory D&H(a)	List Price	Mfr's Suggested Retail Price
<b>OTHER OPTIONS</b>					
<b>Generators:</b>					
<i>55-Amp Delcotron.</i> Not available when C69 Front and Rear Air Conditioning is specified. Included when C60 Front Air Conditioning or V10 Cold-Climate Package is specified. . . . .	0 0	K77	N.A.	47.00	47.00
<i>63-Amp Delcotron.</i> Included when Z82 Trailing Special or C69 Front and Rear Air Conditioning is specified.					
Without C60 Front Air Conditioning or V10 Cold-Climate Package . . . . .	0 0	K81	N.A.	51.00	51.00
With C60 Front Air Conditioning or V10 Cold-Climate Package . . . . .	0 0	K81	N.A.	4.00	4.00
<b>Glass:</b>					
<i>Deep Tint.</i> . . . . .	0 0	AJ1	N.A.	212.00	212.00
<i>Deep Tint with Tinted Rear Window.</i> Includes tinted glass on passenger and driver's side door. Not available when AO1 Tinted or AJ1 Deep Tint Glass is specified. . . . .	0 0	AA3	N.A.	180.00	180.00
<b>Halogen Hi-Beam Headlamps:</b> Available only when V22 Appearance Package or YE9 Silverado is specified. . . . .					
	4 -1	TT5	N.A.	26.00	26.00
<b>Harness, Trailer Wiring: Heavy-Duty 7-Lead.</b> Included when Z82 Trailing Special is specified. . . . .					
	0 3	UY7	N.A.	37.00	37.00
<b>Headlamp Warning Buzzer.</b> . . . . .					
	0 0	T63	N.A.	9.00	9.00
<b>Headliner, Interior: Full Length.</b> Included when YE9 Silverado, Z62 Scottsdale, C60 Front or C69 Front and Rear Air Conditioning is specified. Includes C91 Dome Lamp . . . . .					
	7 19	BB5	N.A.	116.00	116.00
<b>Lamps:</b>					
<i>Dome.</i> Included when BB5 Headliner, Z62 Scottsdale, YE9 Silverado, C60 Front or C69 Front and Rear Air Conditioning is specified. Includes door actuated switches and bright bezels . . . . .	1 0	C91	N.A.	36.00	36.00
<i>Roof Marker.</i> Five. Not available when YF5 California Emissions are specified. . . . .	1 0	U01	N.A.	39.00	39.00
<b>Lighter, Cigarette:</b> Included when YE9 Silverado or Z62 Scottsdale is specified. . . . .					
	0 0	U37	N.A.	24.00	24.00
<b>Mirror, Visor:</b> Included when YE9 Silverado is specified. . . . .					
	1 0	D34	N.A.	6.00	6.00
<b>Mirrors, Exterior: LH and RH.</b>					
<i>Below-Eye-Line Type. 9" x 6.5"</i>					
<i>Painted</i> . . . . .	7 2	D44	N.A.	39.00	39.00
<i>Stainless Steel</i> . . . . .	7 2	D45	N.A.	63.00	63.00
<i>Camper Type. 7.5" x 10.5".</i> Stainless steel. Adjustable arm feature to provide field of vision for vehicles to 96" wide. Shipped loose for dealer installation. . . . .	9 3	DF2	N.A.	74.00	74.00
<b>Moldings:</b>					
<i>Body Side, Black.</i> Bright with black insert. Not available when YE9 Silverado, B85 Bright Body Side Molding or YG3 Deluxe Molding Package is specified. Included when YG1 Custom Molding Package, ZY3 Special Two-Tone Paint, ZY5 Exterior Decor Package or Z62 Scottsdale is specified. Includes lower side and rear moldings of black plastic with bright trim. . . . .	4 4	B84	N.A.	92.00	92.00
<i>Body Side, Bright.</i> Not available when ZY3 Special Two-Tone Paint, ZY5 Exterior Decor Package, B84 Black Body Side Moldings or YG1 Custom Package is specified. Included when YG3 Deluxe Molding Package or YE9 Silverado is specified. Includes bright plastic body side and rear lower moldings with black paint trim plus bright trim for front side marker lights and taillights. . . . .					
Without Z62 Scottsdale . . . . .	2 3	B85	N.A.	115.00	115.00
With Z62 Scottsdale . . . . .	2 3	B85	N.A.	12.00	12.00
<i>Custom Package.</i> Not available when B85 Bright Body Side Moldings, YE9 Silverado or YG3 Deluxe Molding Package is specified. Included when ZY3 Special Two-Tone Paint or ZY5 Exterior Decor Package is specified. Includes bright trim for front side marker lamps and taillights, B84 Black Body Side and B96 Wheel Opening Moldings. . . . .					
Without Z62 Scottsdale . . . . .	8 9	YG1	N.A.	126.00	126.00
With Z62 Scottsdale . . . . .	3 4	YG1	N.A.	23.00	23.00

(a) D & H Charges on vehicle and optional equipment include reimbursement to Chevrolet Motor Division for any tax that it has paid, incurred or agreed to pay thereon.  
 ◇ State and local taxes not included.

# SUBURBAN

## OPTIONS AND ACCESSORIES WHEN INSTALLED BY CHEVROLET

Prices shown are effective with vehicles produced on or after January 5, 1981.

Description	Added Weight (F R)	Option Number	Factory D&H(a)	List Price	Mfr's Suggested Retail Price
<b>OTHER OPTIONS</b>					
<b>Moldings: (Continued)</b>					
<i>Deluxe Package.</i> Included when YE9 Silverado is specified. Includes B85 Bright Body Side Moldings, bright trim for front side marker lamps and taillights and B96 Wheel Opening Moldings. Without ZY3 Special Two-Tone Paint, Z62 Scottsdale or ZY5 Exterior Decor Package					
With ZY3 Special Two-Tone Paint or ZY5 Exterior Decor Package	6 8	YG3	N.A.	138 00	138 00
With Z62 Scottsdale	4 5	YG3	N.A.	12 00	12 00
<i>Guards, Door Edge.</i>	4 5	YG3	N.A.	35 00	35 00
<i>Wheel Opening.</i> Included when YG1 Custom Molding Package and YG3 Deluxe Molding Package is specified.	0 0	B93	N.A.	18 00	18 00
<b>Operating Convenience Package:</b> Available only when Z62 Scottsdale, YE9 Silverado, C60 Front or C69 Front and Rear Air Conditioning or B85 Interior Headliner are specified. Includes A31 Power Windows and AU3 Power Door Locks.	1 1	B96	N.A.	23 00	23 00
<b>Paints, Exterior:</b> See Interior and Exterior Color Selection Chart for ordering information.	12 7	ZQ2	N.A.	372 00	372 00
<i>Solid.</i>	0 0	ZY1	NO ADDITIONAL CHARGE		
<i>Special Two-Tone.</i> Area between side moldings painted secondary color.					
Without Z62 Scottsdale or YE9 Silverado. Includes YG1 Custom Molding Package and B96 Wheel Opening Moldings.	8 9	ZY3	N.A.	256 00	256 00
With Z62 Scottsdale. Includes YG1 Custom Molding Package and B96 Wheel Opening Moldings.	4 5	ZY3	N.A.	153 00	153 00
With YE9 Silverado	4 5	ZY3	N.A.	130 00	130 00
<i>Exterior Decor Package.</i> Includes hood ornament and dual-tone body side and rear decal striping. Areas between decal stripes and body side molding painted secondary color choice.					
Without Z62 Scottsdale or YE9 Silverado. Includes YG1 Custom Package, B96 Wheel Opening Moldings, hood ornament and hood accent stripes.	4 5	ZY5	N.A.	369 00	369 00
With Z62 Scottsdale. Includes YG1 Custom Package, B96 Wheel Opening Moldings, hood ornament and hood accent stripes.	8 9	ZY5	N.A.	266 00	266 00
With YE9 Silverado	4 5	ZY5	N.A.	243 00	243 00
<b>Radio Equipment:</b>					
<i>AM Radio.</i>	5 1	U63	N.A.	90 00	90 00
<i>AM /FM Radio.</i>	7 1	U69	N.A.	141 00	141 00
<i>AM /FM Stereo Radio.</i>	15 4	U58	N.A.	224 00	224 00
<i>AM /FM Stereo Radio with 8 Track Stereo Tape.</i>	14 3	UM2	N.A.	320 00	320 00
<i>AM /FM Stereo Radio with Stereo Cassette Tape.</i>	13 5	UN3	N.A.	325 00	325 00
<i>AM /FM /Citizens Band Radio with Triband Mast Antenna.</i> Available only when U80 Rear Speaker is specified.	8 2	UP5	N.A.	420 00	420 00
<i>Speaker, Rear Auxiliary.</i> Available only when U63 AM Radio, U69 AM /FM Radio or UP5 AM /FM Citizens Band Radio is specified	0 2	U80	N.A.	19 00	19 00
<i>Windshield Antenna.</i> Included when U63, U69, UM2, UN3 or U58 Radio is specified. Not available when UP5 Radio is specified.	0 0	U76	N.A.	27 00	27 00
<b>Seats:</b> Seat trim matches front seat whether standard or optional. Includes seat area floor covering, floor insulation and (3) seat belts.					
<i>Dealer Note - One of the following seat options must be specified. (Added weight includes passenger weight allowance of 150-lbs per seating position).</i>					
<i>Center only. Non-adjustable type with independent LH and RH folding sections</i>					
Without Z62 Scottsdale	170 419	AT5	N.A.	301 00	301 00
With Z62 Scottsdale	168 407	AT5	N.A.	301 00	301 00

(a) D & H Charges on vehicle and optional equipment include reimbursement to Chevrolet Motor Division for any tax that it has paid, incurred or agreed to pay thereon.  
 ◇ State and local taxes not included.

# SUBURBAN

## OPTIONS AND ACCESSORIES WHEN INSTALLED BY CHEVROLET

Prices shown are effective with vehicles produced on or after January 5, 1981.

Description	Added Weight (F R)	Option Number	Factory D&H(a)	List Price	Mfr's Suggested Retail Price <sup>◇</sup>
<b>OTHER OPTIONS</b>					
<b>Seats: (Continued)</b>					
<i>Center and Rear</i> Includes non-adjustable center and quick release removable type rear seats, (3) additional seat belts plus LH and RH rear arm rests with ash trays.					
C10 series only. Available only when PR or PW P235 /75R-15 tires are specified. Also includes F59 Stabilizer					
Without Z62 Scottsdale	211 912	AS3	N.A.	588.00	588.00
With Z62 Scottsdale	207 900	AS3	N.A.	588.00	588.00
C-K20 or K10 series only. K10 Available only when PR or PW P235 /75R-15 tires are specified					
Without Z62 Scottsdale	191 912	AS3	N.A.	561.00	561.00
With Z62 Scottsdale	187 900	AS3	N.A.	561.00	561.00
Optional Seat Not Desired	0 0	YG4	NO ADDITIONAL CHARGE		
<b>Seat Trim:</b> Driver and Passenger.					
<i>Vinyl Bench Seat.</i> Not available when Z62 Scottsdale or YE9 Silverado is specified.					
	0 0	...	NO ADDITIONAL CHARGE		
<i>Special Custom Cloth Bench Seat.</i> Available only when Z62 Scottsdale or YE9 Silverado is specified.					
With Z62 Scottsdale					
Without AT5 or AS3 Seats	0 0	...	N.A.	42.00	42.00
With AT5 Center Seat without AS3 Center and Rear Seats. Includes full floor mats	0 0	...	N.A.	101.00	101.00
With AS3 Center and Rear Seats. Includes full floor mats	0 0	...	N.A.	143.00	143.00
With YE9 Silverado					
Without AT5 or AS3 Seats	0 0	...	NO ADDITIONAL CHARGE		
With AT5 Center Seat without AS3 Center and Rear Seats. Includes full Carpeting	0 0	...	N.A.	119.00	119.00
With AS3 Center and Rear Seats. Includes full Carpeting	0 0	...	N.A.	161.00	161.00
<i>Custom Vinyl Bench Seat.</i> Available only when Z62 Scottsdale or YE9 Silverado is specified.					
With Z62 Scottsdale					
Without AT5 or AS3 Seats	0 0	...	N.A.	42.00	42.00
With AT5 Center Seat without AS3 Center and Rear Seats. Includes full floor mats	0 0	...	N.A.	101.00	101.00
With AS3 Center and Rear Seats. Includes full floor mats	0 0	...	N.A.	143.00	143.00
With YE9 Silverado					
Without AT5 or AS3 Seats	0 0	...	NO ADDITIONAL CHARGE		
With AT5 Center Seat without AS3 Center and Rear Seats. Includes full Carpeting	0 0	...	N.A.	119.00	119.00
With AS3 Center and Rear Seats. Includes full Carpeting	0 0	...	N.A.	161.00	161.00
<i>Special Custom Cloth High Back Bucket Seats.</i> Available only when YE9 Silverado is specified. Includes center console.					
Without AT5 Center Seat or AS3 Center and Rear Seats	-67 -70	...	N.A.	194.00	194.00
With AT5 Center Seat Without AS3 Center and Rear Seats. Includes full carpeting	-67 -70	...	N.A.	313.00	313.00
With AS3 Center and Rear Seats. Includes full carpeting	-67 -70	...	N.A.	355.00	355.00
<i>Custom Vinyl High Back Bucket Seats.</i> Available only when YE9 Silverado is specified. Includes center console.					
Without AT5 Center Seat or AS3 Center and Rear Seats	-67 -70	...	N.A.	194.00	194.00
With AT5 Center Seat without AS3 Center and Rear Seats. Includes full Carpeting	-67 -70	...	N.A.	313.00	313.00
With AS3 Center and Rear Seats. Includes full Carpeting	-67 -70	...	N.A.	355.00	355.00
<b>Shield, Fuel Tank:</b>					
C10-20 series only					
Without NE2 Fuel Tank	-5 25	NY1	N.A.	40.00	40.00
With NE2 Fuel Tank	-6 33	NY1	N.A.	101.00	101.00
K10-20 series only. Includes transfer case skid plate.					
Without NE2 Fuel Tank	7 46	NY1	N.A.	74.00	74.00
With NE2 Fuel Tank	7 46	NY1	N.A.	135.00	135.00
<b>Shock Absorbers:</b> <i>Front and Rear, Heavy-Duty.</i> C10 series only. Standard on K10 and C-K20. Included when Z82 Trailering Special is specified.					
	1 1	F51	N.A.	27.00	27.00

(a) D & H Charges on vehicle and optional equipment include reimbursement to Chevrolet Motor Division for any tax that it has paid, incurred or agreed to pay thereon.  
<sup>◇</sup> State and local taxes not included.

# SUBURBAN

## OPTIONS AND ACCESSORIES WHEN INSTALLED BY CHEVROLET

Prices shown are effective with vehicles produced on or after January 5, 1981.

Description	Added Weight (F R)	Option Number	Factory D&H(a)	List Price	Mfr's Suggested Retail Price (◇)
<b>OTHER OPTIONS</b>					
<b>Shocks, Front Quad:</b> K10-20 series only. Includes dual left and right hand shock absorbers on front, heavy duty shock absorbers on rear and a front axle nose bumper to limit axle windup.					
K10 series only.....	9 0	Z75	N.A.	103.00	103.00
K20 series only.....	5 5	Z75	N.A.	76.00	76.00
<b>Speed Control:</b> Automatic with Resume Speed. Available only when MX1 Automatic Transmission is specified.....					
	8 0	K35	N.A.	132.00	132.00
<b>Springs:</b> Front, Heavy-Duty. Capacity 2250-lb each.					
K10 series only. Recommended for snowplow type usage only. Includes heavy duty front and rear shock absorbers.					
Without Z75 Front Quad Shocks.....	27 0	F60	N.A.	74.00	74.00
With Z75 Front Quad Shocks.....	27 0	F60	N.A.	47.00	47.00
K20 series only.....	27 0	F60	N.A.	47.00	47.00
<b>Stabilizers:</b>					
Front. 1" diameter. Included on C10 series when AS3 Seats are specified.....					
	20 0	F59	N.A.	27.00	27.00
Front, Heavy-Duty. 1.25" diameter. Standard on K10-20 series.....					
	6 0	F58	N.A.	16.00	16.00
<b>Steering, Power:</b> Standard on K10-20 series. Included when Z82 Trailing Special is specified.....					
	29 0	N41	N.A.	205.00	205.00
<b>Steering Wheels:</b>					
Comfortilt. Available only when MM4 4-speed manual or MX1 Automatic Transmission is specified.					
With MX1 Automatic Transmission.....	2 1	N33	N.A.	81.00	81.00
With MM4 4-speed transmission.....	3 1	N33	N.A.	81.00	81.00
Custom. Includes 16" steering wheel. Included when YE9 Silverado is specified.....					
	0 0	N31	N.A.	16.00	16.00
<b>Tank, Fuel:</b> Replaces production fuel tank.					
Approximately 31-Gallon Capacity.....	-7 48	NK7	N.A.	34.00	34.00
Approximately 40-Gallon Capacity.....	-15 124	NE2	N.A.	80.00	80.00
<b>Tires:</b> See following pages					
<b>Towing Device:</b> Two front towing hooks. K10-20 series only					
	11 -2	V76	N.A.	30.00	30.00
<b>Trailer Hitch:</b>					
Deadweight Type. Not available when Z82 Trailing Special is specified.....					
	-9 30	VR2	N.A.	45.00	45.00
Weight Distributing Platform Type. Included when Z82 Trailing Special is specified.....					
	-22 76	VR4	N.A.	127.00	127.00

(a) D & H Charges on vehicle and optional equipment include reimbursement to Chevrolet Motor Division for any tax that it has paid, incurred or agreed to pay thereon.  
 ◇ State and local taxes not included.

# SUBURBAN

## OPTIONS AND ACCESSORIES WHEN INSTALLED BY CHEVROLET

Prices shown are effective with vehicles produced on or after January 5, 1981.

Description	Added Weight (F R)	Option Number	Factory D&H(a)	List Price	Mfr's Suggested Retail Price ◊
<b>OTHER OPTIONS</b>					
<b>Trailer Special:</b> Includes VR4 Trailer Hitch, UY7 Wiring Harness, K81 63-Amp Generator, KC4 Engine Cooler, V02 Transmission Oil Cooler and Trailer Special Emblem. See <i>Trailer Guide in Recreational Vehicles Section for GVW Ratings with available power team combinations</i>					
C10 Series only. Available only when MX1 Automatic Transmission, LS9 5.7 Liter Engine and 3.73 Rear Axle Ratio is specified. Also requires V01 HD Radiator unless C60 Front Air Conditioning or C69 Front and Rear Air Conditioning is specified. Also includes N41 Power Steering and F51 HD Shocks					
Without C60 Front or C69 Front and Rear Air Conditioning . . . . .	23 69	Z82	N.A.	589.00	589.00
With C60 Front Air Conditioning . . . . .	23 69	Z82	N.A.	542.00	542.00
With C69 Front and Rear Air Conditioning . . . . .	23 69	Z62	N.A.	538.00	538.00
C20 Series only. Available only when MX1 Automatic Transmission is specified. With LE8 7.4 Liter Engine available only when 3.73 or 4.10 Rear Axle is specified. With LT9 5.7 Liter Engine available only when 4.10 Rear Axle is specified. Also includes N41 Power Steering.					
Without C60 Front or C69 Front and Rear Air Conditioning . . . . .	23 69	Z82	N.A.	562.00	562.00
With C60 Front Air Conditioning . . . . .	23 69	Z82	N.A.	515.00	515.00
With C69 Front and Rear Air Conditioning . . . . .	23 69	Z82	N.A.	511.00	511.00
K10-20 Series only. Available only when MX1 Automatic Transmission and 3.73 Rear Axle Ratio is specified. Also requires V01 HD Radiator unless C60 Front Air Conditioning is specified.					
Without C60 Front or C69 Front and Rear Air Conditioning . . . . .	-6 69	Z82	N.A.	357.00	357.00
With C60 Front Air Conditioning . . . . .	-6 69	Z82	N.A.	310.00	310.00
With C69 Front and Rear Air Conditioning . . . . .	-6 69	Z82	N.A.	306.00	306.00
<b>Wheel Trim:</b> Bright Metal.					
<i>Trim Rings.</i> Not available when P215 /75R-15 are specified. Included when N67 Rally Wheels are specified . . . . .					
	2 2	P06	N.A.	45.00	45.00
<i>Wheel Covers.</i>					
C10 series only. . . . .	1 1	P01	N.A.	24.00	24.00
C20 series only. . . . .	1 1	P01	N.A.	69.00	69.00
K10 series only. . . . .	3 3	P01	N.A.	24.00	24.00
K20 series only. . . . .	3 3	P01	N.A.	69.00	69.00
<b>Wheels:</b> C-K10 series only					
<i>Aluminum, Forged</i>					
C10 series only. . . . .	-2 -2	PH7	N.A.	360.00	360.00
K10 series only. . . . .	-7 -6	PH7	N.A.	360.00	360.00
<i>Rally.</i> Includes special hub caps and P06 Trim Rings. C-K10 series only. . . . .					
	3 3	N67	N.A.	88.00	88.00
<i>Styled.</i> C-K10 series only. . . . .					
	2 32	PA6	N.A.	176.00	176.00
<b>Windows:</b> <i>Electric.</i>					
<i>Power Side Door Glass.</i> Available only when BB5 Headliner, Z62 Scottsdale, YE9 Silverado, C60 Front or C69 Front and Rear Air Conditioning is specified. Included when ZQ2 Operating Convenience Package is specified. . . . .					
	9 6	A31	N.A.	225.00	225.00
<i>Power Tailgate.</i> Available only when E55 tailgate is specified. . . . .					
	-3 10	A33	N.A.	67.00	67.00
<b>Windshield Wiper System:</b> <i>Intermittent</i> . . . . .					
	1 0	CD4	N.A.	34.00	34.00

(a) D & H Charges on vehicle and optional equipment include reimbursement to Chevrolet Motor Division for any tax that it has paid, incurred or agreed to pay thereon.  
 ◊ State and local taxes not included.



# SUBURBAN

## FACTORY INSTALLED TIRES

See Tire Chart for Available Front/Rear Combinations.

Spare tire available to match either front or rear tires.

Prices shown are effective with vehicles produced on or after January 5, 1981.

Tire Size and Type	Rim Width Included in Tire Option	Added Weight (F) (R)	Option Number	Factory D&H(a)	List Price	Mfr's Suggested Retail Price ◊
<b>Tires</b>						
<b>C-K10 series</b>						
TUBELESS						
<i>P215 /75R15 Highway Steel Belted Radial Ply Blackwall.</i>						
(Maximum Capacity 1583 lbs.)						
K10 series only.						
Front (Standard) .....	6.00	0 0	XKT		NO ADDITIONAL CHARGE	
Rear (Standard) .....	6.00	0 0	YKT		NO ADDITIONAL CHARGE	
Spare (Standard) .....	6.00	0 0	ZKT		NO ADDITIONAL CHARGE	
<i>P215 /75R15 Highway Steel Belted Radial Ply Whitewall</i>						
(Maximum Capacity 1583 lbs.)						
K10 series only.						
Front .....	6.00	0 0	XKU	N.C.	24.00	24.00
Rear .....	6.00	0 0	YKU	N.C.	24.00	24.00
Spare .....	6.00	0 1	ZKU	N.C.	12.00	12.00
<i>P235 /75R15 Highway Steel Belted Radial Ply Blackwall</i>						
(Maximum Capacity 1843 lbs.)						
Front						
C10 series only (Standard) .....	6.00	0 0	XBD		NO ADDITIONAL CHARGE	
K10 series only .....	6.00	9 0	XBD	.72	40.00	40.72
Rear						
C10 series only (Standard) .....	6.00	0 0	YBD		NO ADDITIONAL CHARGE	
K10 series only .....	6.00	0 9	YBD	.72	40.00	40.72
Spare						
C10 series only (Standard) .....	6.00	0 0	ZBD		NO ADDITIONAL CHARGE	
K10 series only .....	6.00	-1 4	ZBD	.36	20.00	20.36
<i>P235 /75R15 On-Off Road Steel Belted Radial Ply Blackwall</i>						
(Maximum Capacity 1843 lbs.)						
Front. K10 series only .....						
	6.00	15 0	XQJ	1.22	54.00	55.22
Rear						
C10 series only .....	6.00	0 6	YQJ	.50	14.00	14.50
K10 series only .....	6.00	0 15	YQJ	1.22	54.00	55.22
Spare						
C10 series only .....	6.00	-1 4	ZQJ	.25	7.00	7.25
K10 series only .....	6.00	-1 4	ZQJ	.61	27.00	27.61
<i>P235 /75R15 Highway Steel Belted Radial Ply Whitewall</i>						
(Maximum Capacity 1843 lbs.)						
Front						
C10 series only .....	6.00	0 0	XBJ	N.C.	28.00	28.00
K10 series only .....	6.00	9 0	XBJ	.72	68.00	68.72
Rear						
C10 series only .....	6.00	0 0	YBJ	N.C.	28.00	28.00
K10 series only .....	6.00	0 9	YBJ	.72	68.00	68.72
Spare						
C10 series only .....	6.00	0 0	ZBJ	N.C.	14.00	14.00
K10 series only .....	6.00	-1 6	ZBJ	.36	34.00	34.36
<i>P235 /75R15 XL Highway Steel Belted Radial Ply Blackwall</i>						
(Maximum Capacity 1910 lbs.)						
Front						
C10 series only .....	6.00	0 0	XPR	.04	12.00	12.04
K10 series only .....	6.00	9 0	XPR	.76	52.00	52.76
Rear						
C10 series only .....	6.00	0 0	YPR	.04	12.00	12.04
K10 series only .....	6.00	0 9	YPR	.76	52.00	52.76
Spare						
C10 series only .....	6.00	0 0	ZPR	.02	6.00	6.02
K10 series only .....	6.00	-1 6	ZPR	.38	26.00	26.38

(a) D & H Charges on vehicle and optional equipment include reimbursement to Chevrolet Motor Division for any tax that it has paid, incurred or agreed to pay thereon.

◊ State and local taxes not included.

# SUBURBAN

## FACTORY INSTALLED TIRES

See Tire Chart for Available Front/Rear Combinations.

Spare tire available to match either front or rear tires.

Prices shown are effective with vehicles produced on or after January 5, 1981.

Tire Size and Type	Rim Width Included in Tire Option	Added Weight (F) (R)	Option Number	Factory D&H(a)	List Price	Mfr's Suggested Retail Price◇
<b>P235 /75R15 XL Highway Steel Belted Radial Ply Whitewall</b> (Maximum Capacity 1910 lbs.)						
Front						
C10 series only	6.00	0 0	XPW	.04	40.00	40.04
K10 series only	6.00	9 0	XPW	.76	80.00	80.76
Rear						
C10 series only	6.00	0 0	YPW	.04	40.00	40.04
K10 series only	6.00	0 9	YPW	.76	80.00	80.76
Spare						
C10 series only	6.00	0 0	ZPW	.02	20.00	20.02
K10 series only	6.00	-1 6	ZPW	.38	40.00	40.38
<b>C-K20 Series</b>						
TUBELESS						
<b>9.50-16.5 /D Highway Polyester Blackwall</b> (Maximum Capacity 2780 lbs.)						
Front. C-K20 series only (Standard)	6.75	0 0	XUF	NO ADDITIONAL CHARGE		
<b>9.50-16.5 /E Highway Polyester Blackwall</b> (Maximum Capacity 3170 lbs.)						
Front						
C20 series only	6.75	4 0	XUC	.68	28.00	28.68
K20 series only	6.75	7 0	XUC	.68	28.00	28.68
Rear						
C20 series only (Standard)	6.75	0 0	YUC	NO ADDITIONAL CHARGE		
K20 series only (Standard)	6.75	0 28	YUC	NO ADDITIONAL CHARGE		
Spare						
C20 series only	6.75	-18 96	ZUC	4.82	199.00	203.82
K20 series only	6.75	-19 103	ZUC	4.82	199.00	203.82
<b>9.50-16.5 /E On-Off Road Nylon Ply Blackwall</b> (Maximum Capacity 3170 lbs.)						
Front. K20 series only	6.75	3 0	XUH	1.36	54.00	55.36
Rear						
C20 series only	6.75	0 0	YUH	.68	26.00	26.68
K20 series only	6.75	0 3	YUH	.68	26.00	26.68
Spare	6.75	-17 102	ZUH	5.16	212.00	217.16

(a) D & H Charges on vehicle and optional equipment include reimbursement to Chevrolet Motor Division for any tax that it has paid, incurred or agreed to pay thereon.  
◇ State and local taxes not included.

# **SUBURBAN**

**CAB & BODY FEATURES  
CAB DIMENSIONS  
SEATING ARRANGEMENTS  
COLOR & TRIM CHARTS  
TWO-TONES**

# SUBURBAN

## CUSTOM DELUXE FEATURES—STANDARD MODEL

The Custom Deluxe standard models include the following items as standard equipment



### EXTERIOR

- **Bumpers:** Front and rear; painted white; front bumper incorporates parking lamps
- **Color:** See Interior and Exterior Color Selection Chart
- **Doors:** Four side doors; two LH and two RH; two rear panel doors (optional endgate with drop-glass available)
- **Glass:** Tinted; all windows
- **Grille and Headlamp Bezels:** Molded plastic; painted argent; integral Chevrolet emblem at center of grille includes bright insert with gold trim
- **Horn:** Single, electric, low note
- **Hub Caps:** Bright metal with black and ochre trim
- **Keys:** Two-key system with separate keys for ignition switch and door locks
- **Lights:**
  - Backup lamps: Two rear (integral with taillamps)
  - Combination parking/direction/hazard: Two front
  - Combination tail/stop/direction/hazard: Two rear
  - Headlamps: Two, rectangular; Power Beam
  - License plate lamp: Single rear
  - Side marker lamps with reflectors: Two front; two rear (integral with taillamps)
- **Mirrors:** RH and LH fixed arm with adjustable 5-7/16" wide x 4" high head; chrome finish
- **Moldings:** Bright; drip moldings over side and rear doors; headlamp and grille outline moldings
- **Nameplates:** Bright "Custom Deluxe" nameplates, with series designation, on front fenders near doors; bright "Suburban" nameplate on RH rear door
- **Tools:** Mechanical jack and wheel wrench
- **Wheels:** Painted white
- **Windshield Wipers and Washers:** Electric, 2-speed wipers with bright finish on exposed metal portions; coordinated dual-orifice washers

# SUBURBAN

## CUSTOM DELUXE FEATURES—STANDARD MODEL

The Custom Deluxe standard models include the following items as standard equipment

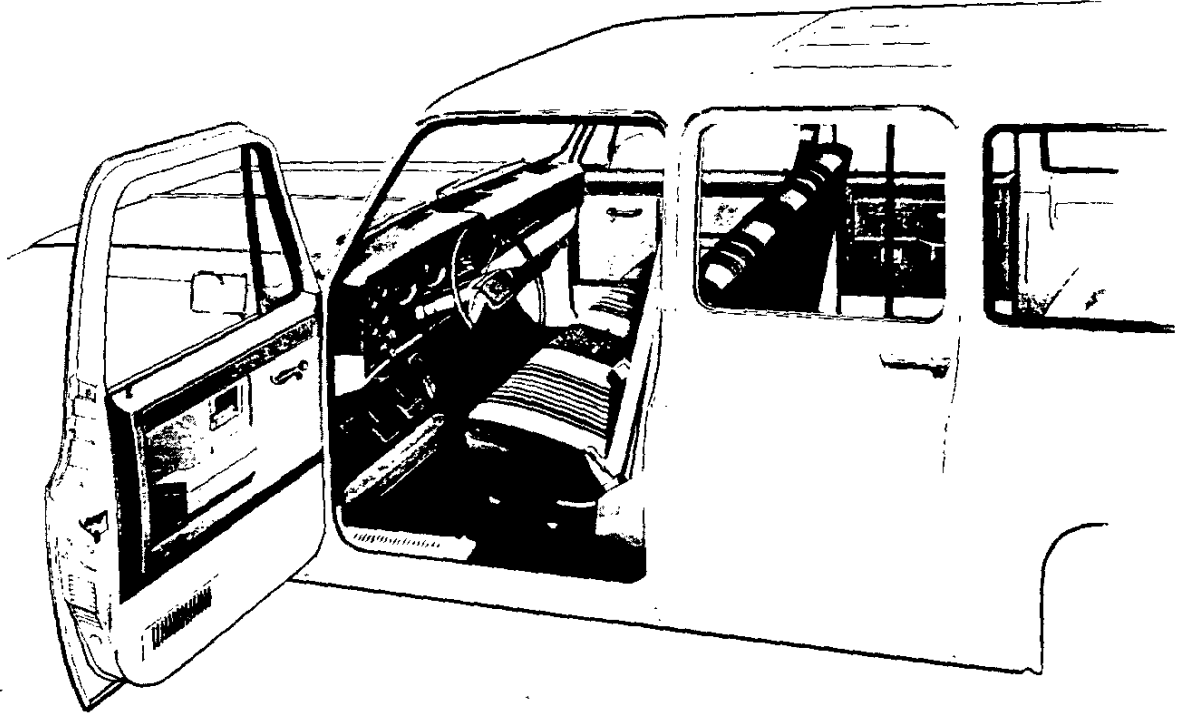

### INTERIOR

- **Armrests:** RH and LH padded; integral with side door trim panels
- **Ashtrays:** In middle of instrument panel and in rear side door trim panels
- **Coat Hooks:** Over RH and LH rear side door openings
- **Colors:**  
Painted areas: Same as exterior primary color choice  
Interior trim: Coordinated with seat trim color choices
- **Floor Covering:** Embossed black rubber mats over entire floor area
- **Heater and Defogger:** Deluxe-air
- **Hood Lock Release:** Handle located on LH side under instrument panel
- **Instrument Cluster Bezel:** Black crackle finish with bright trim
- **Instruments:**  
Gages: Speedometer, odometer and fuel  
Switches: Main, for control of exterior lights, instrument cluster lights, and interior lights; wiper-washer; headlamp beam (foot); ignition; direction signal (with lane change position); hazard warning; heater fan  
Warning lights: Generator, oil pressure, engine temperature, seat belt, service-parking brake, direction/hazard signal, high beam
- **Instrument Panel Control Knobs:** Soft black plastic (except heater and wiper-washer controls) with white graphic identification
- **Instrument Panel Pad:** Color-keyed, energy-absorbing foam type with grained vinyl skin; has black crackle finish applique on RH side with bright, black, and silver trim and bright "Custom Deluxe" nameplate
- **Insulation and Sound Deadening Material:** Dash (firewall), under floor mats and under front seat at center (includes extra-thick insulation in center seat area when optional seat is ordered)
- **Lights:** Instrument cluster and cab interior lights
- **Mirror, Rearview:** 10" prismatic with soft vinyl rim
- **Seat:** Full-width, full-depth foam bench-type front seat only with striped design vinyl trim. See Interior and Exterior Color Selection Chart for color and trim availability
- **Seat Belts:** Front only; non-detachable combination lap and shoulder belts for outboard positions with automatic-locking retractors on lap belts; emergency-locking retractors on shoulder belts, and switch in driver's lap belt retractor for buzzer warning system; lap belt with manual adjustment for center position. All seat belts are color-keyed with pushbutton type buckles
- **Sill Plates:** Door-opening protection and floor mat retention; bright metal; partial for front side doors, full-length for rear side doors, and full-width front and rear for rear compartment platform
- **Spare Tire Carrier:** LH rear side
- **Steering Wheel and Column:** 16" black, soft plastic wheel with 2 spokes; black energy-absorbing steering column with anti-theft locking feature
- **Stowage Box:** In RH side of instrument panel; door has bright turn-type latch release
- **Sunshades:** RH and LH padded; color-keyed
- **Trim Panels:** Color-keyed, embossed molded plastic on side doors with integral armrests; painted steel panels on rear quarter areas

# SUBURBAN

## SCOTTSDALE MODEL OPTION—RPO Z62

This option includes all Custom Deluxe standard model items plus the additions or substitutions listed below



### EXTERIOR

#### • Bright Appearance Items:

- "Scottsdale" nameplates, with series designation, on front fenders
- Body side and rear molding trim
- Front and rear bumpers
- Side marker lamp and taillamp trim

Windshield reveal moldings  
Rear side window trim

- **Horn:** Additional, electric, high-note
- **Moldings:** Black plastic body side and rear moldings with bright trim

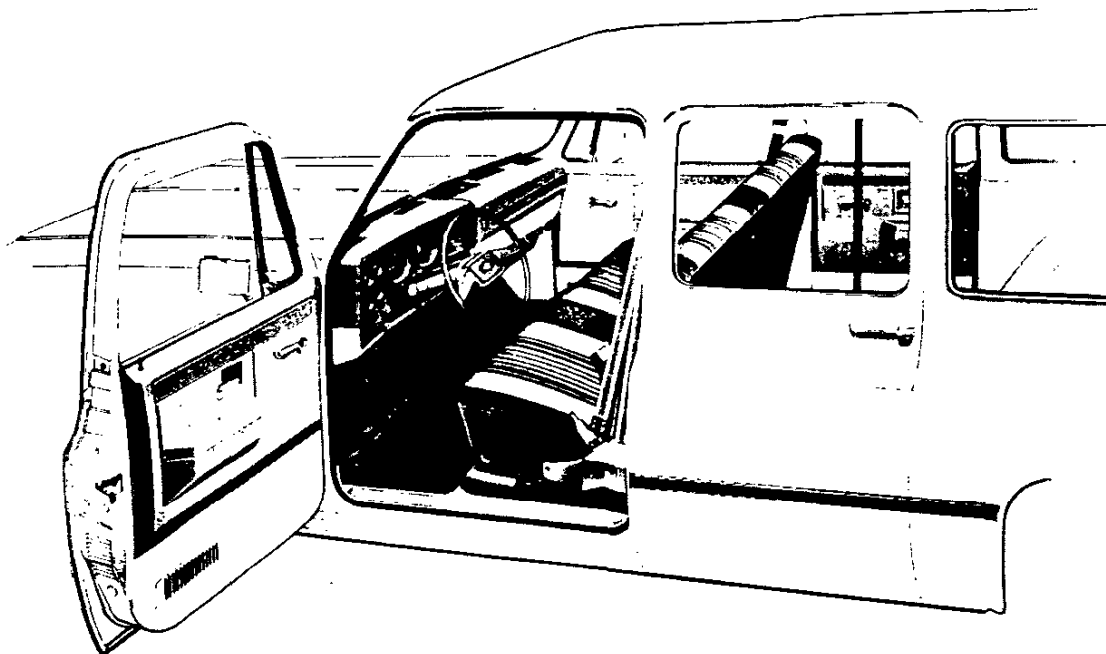

### INTERIOR

#### • Bright Appearance Items:

- "Scottsdale" nameplate on instrument panel pad
- Dome lamp trim
- **Cigar Lighter:** With ashtray light
- **Dome Lamps:** Two; one front, one rear
- **Dome and Interior Lamp Switches:** Front side door actuated (dome and interior lamps also may be activated by main light switch)
- **Floor Covering:** Color-keyed rubber mat in front seat area (also in center and rear seat areas when optional center seat is ordered)
- **Headliner:** Full-length, mystic colored, perforated molded plastic with fiber glass blanket backing; includes matching retainer moldings

- **Insulation:** Under cowl panel and on headliner
- **Pillar Trim Panels:** Mystic colored molded plastic on windshield pillars and center door pillars
- **Seats:** Choice of: 1) striped design vinyl trim (standard); 2) cut pile velour cloth/vinyl trim (at extra cost) or 3) all-vinyl leather grain trim (at extra cost). See Interior and Exterior Color Selection Chart for color and trim availability
- **Sill Plates:** Full-length bright metal for front side doors
- **Spare Tire Cover:** Color-keyed carpet
- **Sunshades:** Mystic colored to match headliner

## SUBURBAN

### SILVERADO MODEL OPTION—RPO YE9

This option includes all items in the Scottsdale model option plus the additions or substitutions listed below



#### EXTERIOR

- **Bright Appearance Items:**  
 "Silverado" nameplates, with series designation, on front fenders  
 Chrome-trimmed grille and headlamp bezels  
 Chevrolet emblem at grille center  
 Body side and rear door (or tailgate) moldings with black paint trim  
 Bright wheel opening lip moldings
- **Body-to-Fender Insulators**
- **Hood Insulator**
- **Secondary Door Seals:** On side door upper frames
- **Special Headlamps:** Rectangular; dual RH and LH

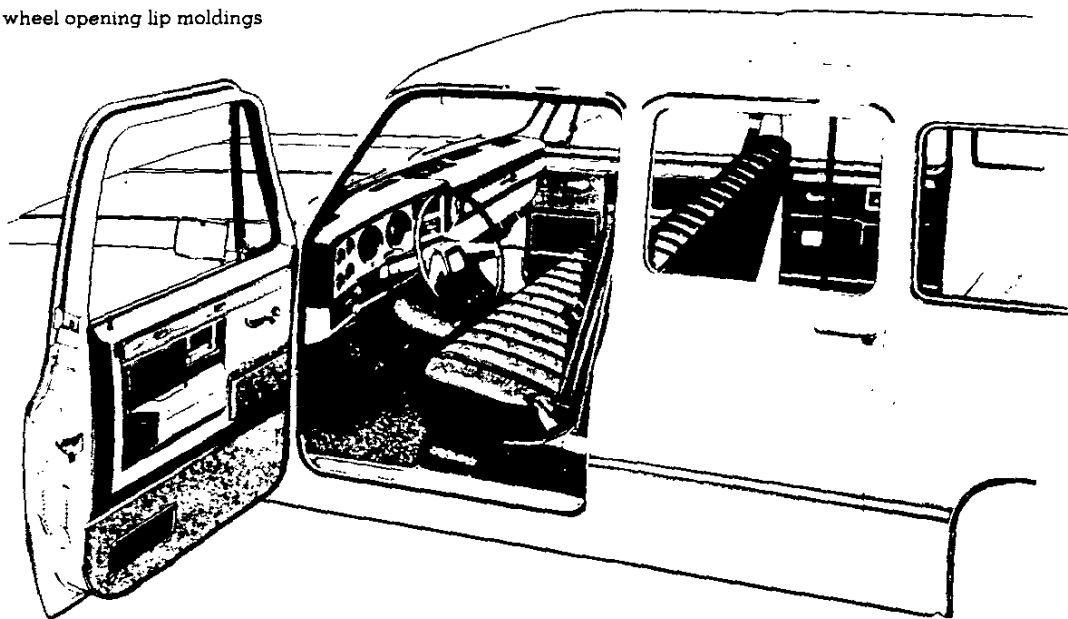

#### INTERIOR

- **Bright Appearance Items:**  
 "Silverado" nameplate on instrument panel pad  
 Four-speed transmission shift lever  
  
 Trim on instrument cluster bezel, instrument panel pad applique, side door trim panels, and on horn button
- **Cowl Trim:** Color-keyed molded plastic on entire surface of cowl side panels
- **Floor Covering:** Color-keyed carpeting; front seat area (also in center and rear seat areas and on wheelhousings when optional center seat is ordered)
- **Instrument Cluster:** Voltmeter, engine temperature gage, and oil pressure gage replace warning lights; includes bright brush-finished bezel
- **Instrument Panel Pad Applique:** Bright brushed finish with bright, black, and silver trim
- **Insulation:** Extra-thick front compartment floor insulators, including full-width insulator under front seat (also in center and rear seat areas when optional center seat is ordered)
- **Seats:** Choice of: 1) all-vinyl leather grain trim or 2) cut pile velour cloth/vinyl trim. See Interior and Exterior Color Selection Chart for color and trim availability
- **Side Door Trim Panels:** Color-keyed molded plastic (with door closing assist strap and vinyl storage pockets on front door units only); includes bright brush-finished upper decorative inserts having bright, black, and silver borders, vinyl inserts in armrest area plus carpeting on lower portions
- **Steering Wheel:** Bright trim on horn button
- **Visor Mirror:** On RH sun visor

## SUBURBAN GENERAL

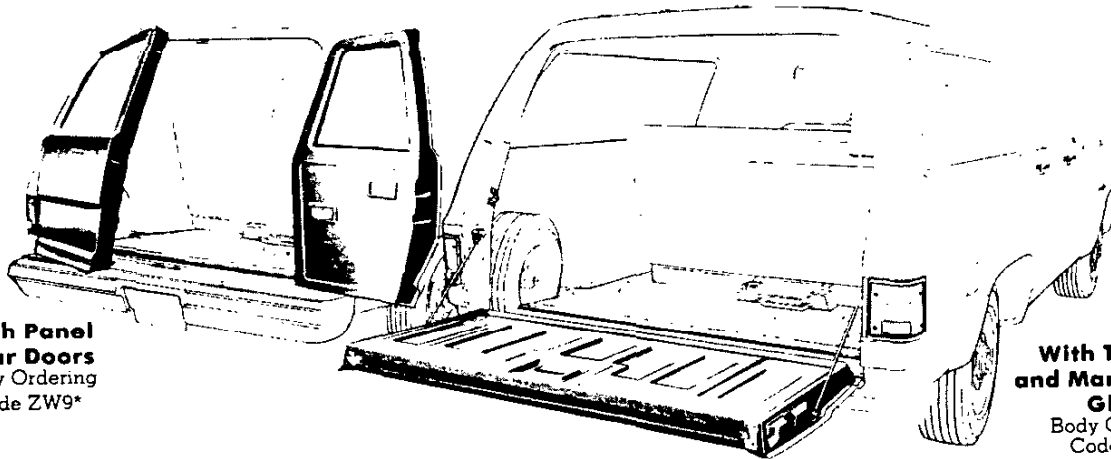

**With Panel  
Rear Doors**  
Body Ordering  
Code ZW9\*

**With Tailgate  
and Manual Drop  
Glass**  
Body Ordering  
Code E55\*

Suburban models have 4 side doors, two front and two rear. Front side doors are equipped with drop-glass and ventipane assemblies; the rear side doors have a drop-glass in the forward portion and fixed glass in the rear portion. The rear quarter windows have fixed glass.

Suburbans ordered with Body Ordering Code ZW9 have panel-type rear doors incorporating fixed glass, positive fork-cam latches, and an outside key lock. A 2-position, strap-type check on each door permits either a 118- or 162-degree door opening, depending on how the retaining pin is positioned; full door opening of 172-degrees is obtained by removing the retaining pin.

Suburbans ordered with Body Ordering Code E55 have a tailgate with a manually-controlled curved drop glass. Operation of the window is through an articulated crank-type regulator handle on the tailgate outer panel, a key lock cylinder is concealed in the regulator handle, and must be unlocked before the window can be lowered. After the window is lowered, the tailgate can be lowered by moving the release handle at the upper center of the tailgate inner panel. When the tailgate is open, it is supported by reel-type cables. Embossments on the tailgate inner panel facilitate loading of large objects. An optional electric tailgate window is available by ordering RPO A33.

\*Both models shown with optional folding center and removable rear seats

## CUSTOM OPTIONS

### Chromed Bumpers & Chromed Bumpers With Rub Strips

(RPO V37, VE5)

Chromed bumpers (RPO V37) and chromed bumpers with rub strips (RPO VE5) are available optionally on all Suburban models.

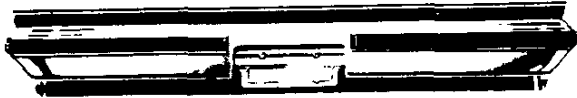

(Chrome bumper with rub strips)

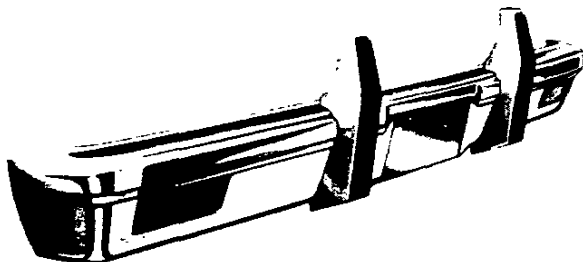

**Chromed Front Bumper Guards**  
(RPO V31)

Chromed front bumper guards (RPO V31) with rub strips are available optionally on Suburban models with chromed front bumpers. Not available when chromed bumpers with rub strips are ordered.

### Custom Trim Moldings

(RPO B84, B96, YG1)

Body side and rear trim moldings (RPO B84) are black plastic with bright trim and are available for standard Suburban models. They are included in the Custom Molding Package (RPO YG1) for standard and Scottsdale models which also includes bright wheel opening moldings with black paint trim (RPO B96) and bright trim for front side marker lamps and taillamps.

(RPO B85, B96, YG3)

Bright plastic body side and rear moldings with black paint trim (RPO B85) are available for standard and Scottsdale Suburban models. They are included in the Deluxe Molding Package (RPO YG3) which also includes the wheel opening moldings (RPO B96) and other bright lamp trim items described above for RPO YG1.

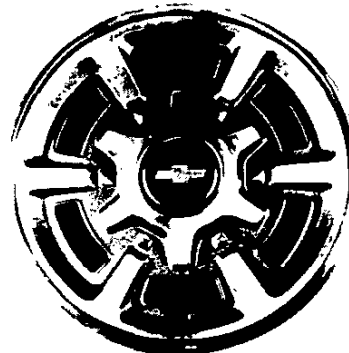

**Wheel Covers**  
(RPO P01)

Stainless steel wheel covers are available on all Suburban models. The front units for K10-20 models with 4WD have a cut-out at the center to clear the axle hubs.



# SUBURBAN

## DIMENSIONS

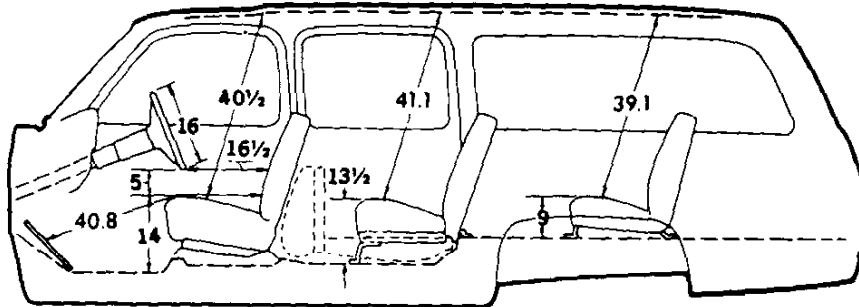

### GLASS AREA (Sq. in.)

Windshield..... 1447  
 Front side door, including  
 ventipane (each side)..... 546  
 Rear side door (each side)..... 488

Side rear window (each side).. 1074  
 Rear:  
 ZW9 panel doors (total)..... 654  
 E55 tailgate..... 1041

## SEATING ARRANGEMENTS

**Front Seat**  
 Standard full-depth foam front seat

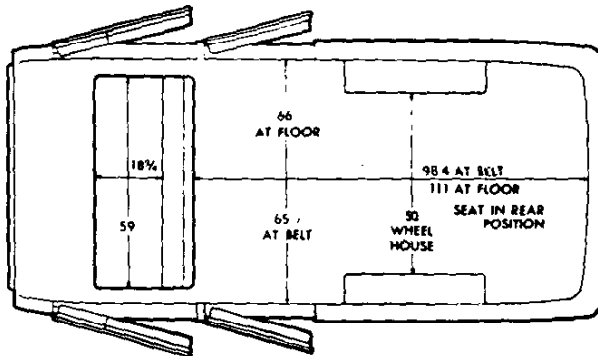

**Front and Folding Center Seats**  
 Standard front and RPO AT5 folding center seats

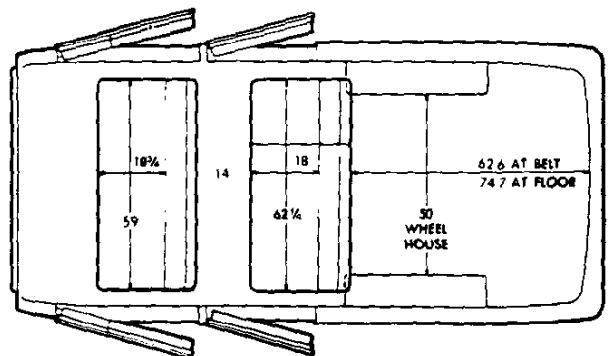

**Front and Folding Center Seats**  
 Standard front and RPO AT5 folding center seats  
 (Center seats shown in folded position)

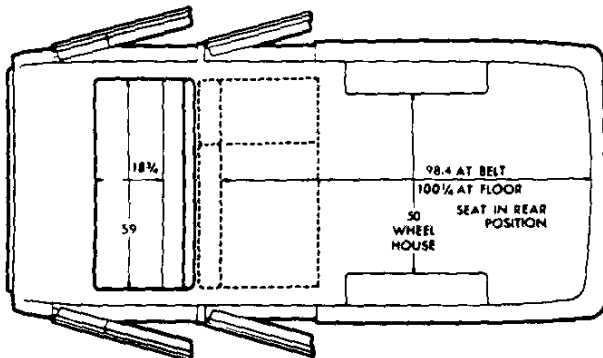

**Front, Folding Center And Rear Removable Seats**  
 Standard front, RPO AT5 folding center and  
 RPO A53 removable rear seats

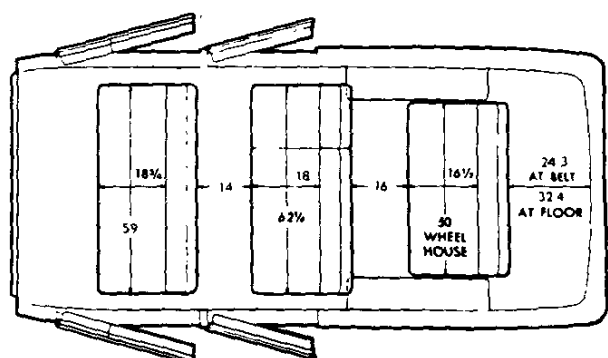

## SUBURBAN INTERIOR AND EXTERIOR COLOR AVAILABILITY CHART

**Please Note:** Exterior and interior paint combinations shown in chart below are those recommended by Chevrolet. Any exterior color combination may be ordered with any available seat trim if the particular combination is desired by a customer.

SEAT TRIM			MODEL OPTION			SEAT TRIM COLOR AND ORDERING CODE			
Fabric	†Code	Type	Custom Deluxe	Scottsdale Z62	Silverado YES	Blue	Doeskin	Carmine	Slate
Standard Vinyl	V	Bench	X	X		VDD1	VCC1		
Custom Vinyl	W	Bench		X	X	XDD1	XCC1	XRR1•	
		Bucket			X		XCC4		
Custom Cloth	D	Bench		X	X	LDD1	LCC1	LRR1•	LTT1•
		Bucket			X				LTT4
•EXTERIOR COLOR			Primary	Secondary	RECOMMENDED INTERIOR TRIM COLOR				
<b>FROST WHITE</b>			12	12	X	X	X	X	
Light Silver Metallic			12	17					X
Medium Blue			12	23	X				
Santa Fe Tan			12	60		X			
Dark Carmine Red			12	71				X	
<b>LIGHT SILVER METALLIC</b>			17	17	X			X	X
Frost White			17	12					X
Dark Carmine Red			17	71				X	X
Midnight Black			17	86					X
<b>CHARCOAL METALLIC</b>			18	18				X	X
Frost White			18	12					X
Light Silver Metallic			18	17					X
Dark Carmine Red			18	71				X	
Midnight Black			18	86					X
<b>MEDIUM BLUE</b>			23	23	X				X
Frost White			23	12	X				
Light Silver Metallic			23	17	X				X
<b>LIGHT BLUE METALLIC</b>			25	25	X				X
Frost White			25	12	X				
Light Silver Metallic			25	17	X				X
Medium Blue			25	23	X				
<b>NORDIC BLUE METALLIC</b>			30	30	X				X
Frost White			30	12	X				X
Light Silver Metallic			30	17	X				X
Medium Blue			30	23	X				X
<b>EMERALD GREEN</b>			43	43			X		
Frost White			43	12			X		
Light Silver Metallic			43	17			X		
<b>COLONIAL YELLOW</b>			53	53			X		
Frost White			53	12			X		
Santa Fe Tan			53	60			X		
<b>SANTA FE TAN</b>			60	60			X	X	
Frost White			60	12			X		
Dark Carmine Red			60	71				X	
<b>DARK CHESTNUT METALLIC</b>			65	65			X		
Frost White			65	12			X		
Santa Fe Tan			65	60			X		
<b>CARMINE RED</b>			70	70			X	X	X
Light Silver Metallic			70	17				X	X
Santa Fe Tan			70	60			X		
Dark Carmine Red			70	71			X	X	X
<b>DARK CARMINE RED</b>			71	71			X	X	X
Frost White			71	12				X	
Light Silver Metallic			71	17				X	X
Santa Fe Tan			71	60			X		
<b>CARDINAL RED</b>			73	73			X	X	X
Frost White			73	12				X	X
Light Silver Metallic			73	17				X	X
Santa Fe Tan			73	60			X		
Dark Carmine Red			73	71				X	
<b>MIDNIGHT BLACK</b>			86	86			X	X	X
Light Silver Metallic			86	17					X
<b>BURNT ORANGE METALLIC</b>			95	95			X		
Frost White			95	12			X		
Santa Fe Tan			95	60			X		
Midnight Black			95	86					

•Primary color shown in **BOLDFACE TYPE**; secondary colors shown in Lightface Type.  
† Seat Trim Codes: V - Striped Vinyl; W - Leather Grain Vinyl; D - Cut Pile Velour Cloth.

• Available Silverado only.

# SUBURBAN

## TWO-TONE EXTERIOR COLOR COMBINATIONS\*

### SOLID COLOR

**Solid color** paint (ZY1) is standard on all models. All painted areas of the body and front end sheet metal are the same color.

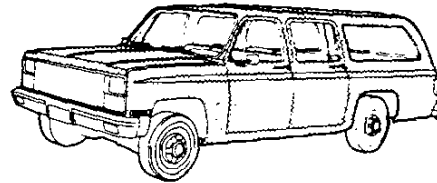

**SOLID PAINT—ZY1**

### SPECIAL TWO-TONE

**Special two-tone** (ZY3) paint colors include the YG1 molding package consisting of black vinyl body side and rear moldings with bright trim, bright wheel opening moldings, and bright trim for front side marker lights and tail lights (except with the YG3 molding package or the Silverado Model Option where bright body side and rear moldings with black paint trim are substituted). The primary color is applied to the areas above the moldings (including the roof). The secondary color is applied to the areas below the moldings.

### SPECIAL TWO-TONE PAINT—ZY3 (Includes YG1 and B96 Moldings)

**Primary Body Color**

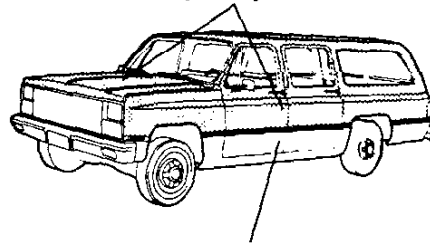

**Secondary Body Color**

### EXTERIOR DECOR PACKAGE

**Exterior Decor Package** (ZY5) paint colors and trim are available in a choice of eight combinations (see chart below). The package includes the moldings described under Special Two-Tone. In addition, it includes dual-tone body side and rear tape decal striping keyed to the exterior body color. This striping is applied to the front fenders, side doors and body sides and rear a few inches above the styling crease line. The areas above the striping and below the molding are painted the primary paint color. The secondary color is used between the striping and the molding. A bright sprung-loaded, stand-up type hood emblem is also included.

### EXTERIOR DECOR PACKAGE—ZY5 (Includes YG1 and B96 Moldings and Hood Ornament)

**Secondary Body Color**

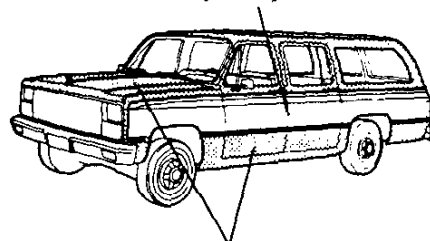

**Primary Body Color**

PRIMARY COLOR	CODE	SECONDARY COLOR	CODE	STRIPE COLORS	INTERIOR COLOR
Light Silver Metallic	17	Midnight Black	86	Vermillion/Black	Slate
Charcoal Metallic	18	Light Silver Metallic	17	Vermillion/Lt. Slate	Slate
Light Blue Metallic	25	Light Silver Metallic	17	Dk. Blue/Lt. Slate	Blue or Slate
Nordic Blue Metallic	30	Light Silver Metallic	17	Vermillion/Lt. Slate	Blue or Slate
Dark Chestnut Metallic	65	Santa Fe Tan	60	Doeskin/Santa Fe Tan	Doeskin
Carmine Red	70	Dark Carmine Red	71	Vermillion/Dk. Carmine Red	Carmine or Slate
Carmine Red	70	Dark Carmine Red	71	Doeskin/Dk. Carmine Red	Doeskin
Midnight Black	86	Light Silver Metallic	17	Vermillion/Lt. Slate	Slate

\*Optional at extra cost.

# SUBURBAN

## TWO-TONE EXTERIOR COLOR COMBINATIONS\*

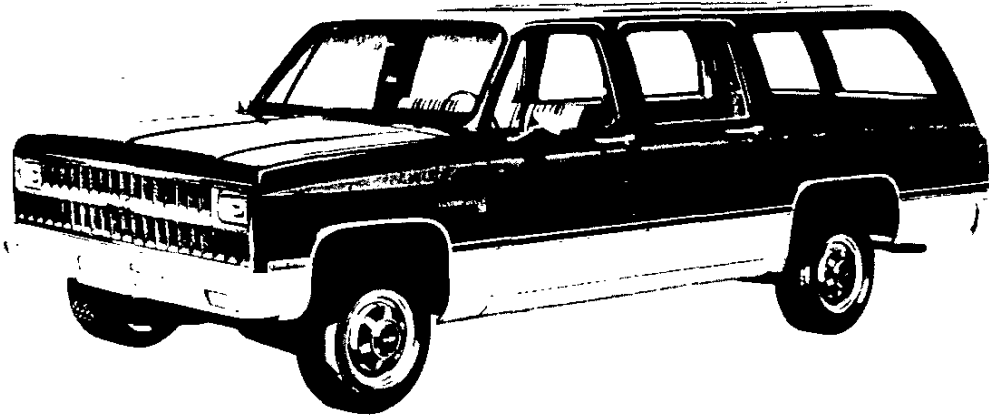

### SPECIAL TWO-TONE

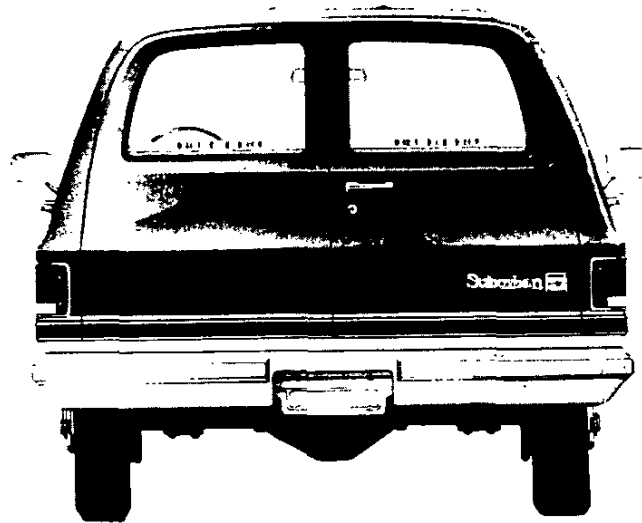

### EXTERIOR DECOR PACKAGE

\*Optional at extra cost.